



LANDFILL GAS CORRECTIVE ACTION UPDATE

BRIDGETON LANDFILL

BRIDGETON, ST. LOUIS COUNTY, MISSOURI

**Submitted Pursuant to Section 23 of Agreed Order
Case No. 13SL-CC01088, Effective May 13, 2013**

**Prepared For:
Bridgeton Landfill, LLC
13570 St. Charles Rock Road
Bridgeton, MO 63044**

July 15, 2018

Project No.: BT-133

Prepared By:

**Feezor Engineering, Inc.
3377 Hollenberg Drive
Bridgeton, MO 63044**

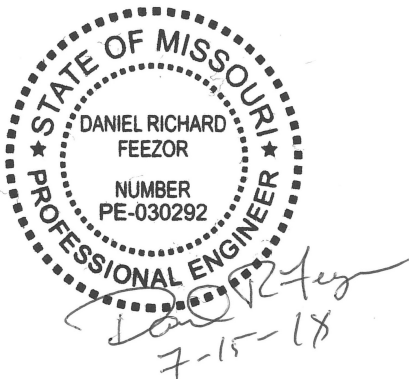

TABLE OF CONTENTS

1.0	INTRODUCTION	1
2.0	REVIEW OF CURRENT GAS MIGRATION CONTROL STATUS	2
3.0	RECENT GAS MIGRATION CONTROL EFFORTS	4
4.0	PROPOSED AND ONGOING GAS MIGRATION CONTROL EFFORTS	5
5.0	CONTINUED MONITORING AND REPORTING	7

TABLES

Table 1:	List of Landfill Gas Monitoring Probes	
Table 2:	Compliance Gas Monitoring Probe Data	(03/29/18 – 06/30/18)
Table 3:	Sentry Gas Monitoring Probe Data	(03/29/18 – 06/30/18)
Table 4:	Investigative Gas Monitoring Probe Data	(03/29/18 – 06/30/18)
Table 5:	Public Safety Gas Monitoring Probe Data	(03/29/18 – 06/30/18)
Table 6:	Gas Monitoring Probe Water Level Data	(03/29/18 – 06/30/18)

APPENDICES

Appendix A:	Text of Landfill Gas Corrective Action Plan Update	(7/26/2013)
Appendix B:	Gas Monitoring Probe Methane Level Graphs	(06/26/2017 – 06/30/2018)
Appendix C:	Infrastructure Site Plan, Gas Monitoring Probes	
Appendix D:	2017 GCCS Improvements	

1.0 INTRODUCTION

On May 13, 2013, Bridgeton Landfill, LLC entered into an Agreed Order with the State of Missouri which requires actions to address a subsurface reaction (SSR) occurring in the South Quarry area of the Bridgeton Landfill (BL). Section 23 of the Agreed Order requires the preparation of an updated “Landfill Gas Corrective Action Plan” (CAP) and requests that the update consider SSR control measures. Bridgeton Landfill, LLC subsequently submitted such an updated CAP on July 26, 2013.

Section 5.0 of the July 2013 CAP proposed that weekly monitoring data would be summarized and reviewed in a quarterly report to be submitted on the 15th day of the month following each quarter. The Missouri Department of Natural Resources (MDNR) accepted this proposal with a letter dated October 18, 2013. Bridgeton Landfill, LLC has subsequently submitted updated Quarterly Corrective Action Plans Updates each quarter. The purpose of this document is to provide monitoring data for the second quarter (March 29, 2018 – June 30, 2018) and to review the current status of gas migration control measures.

The text of the July 2013 CAP is included in **Appendix A** for reference.

2.0 REVIEW OF CURRENT GAS MIGRATION CONTROL STATUS

The BL continues an aggressive monitoring program and significant infrastructure investment with respect to landfill gas migration control at the facility.

Detailed graphs showing approximately one year of methane concentrations as measured in the probes from June 26, 2017 to June 30, 2018 are included in this document as **Appendix B**.

Table 1 lists the gas monitoring probes and their corresponding abbreviations, as presented in the July 2013 CAP, to clarify the historical graphs and the tabulated data for March 29, 2018 through June 30, 2018.

Tables 2 through **5** present tabulated gas monitoring probe data for the monitoring period. Weekly water level readings were proposed by the July 2013 CAP and approved by the October 18, 2013 MDNR letter and are provided as depth to water (from top of well). Results of weekly water level measurements for the monitoring period are provided in **Table 6**.

The following discussion highlights observations regarding methane data observed this monitoring period. A site plan that depicts locations of the gas monitoring probes is provided in **Appendix C**.

Newly Elevated Compliance Probes

No compliance probes exhibited first-time measurements of greater than 2.5% methane this period. All probes measuring greater than 2.5% methane had measured at or above the threshold in prior monitoring periods. Therefore, no new adjacent property notifications were required.

Probes with Greater Than or Equal to 2.5% Methane: Quarterly Review

The following probes exhibited elevated concentrations of methane for at least a portion of the current monitoring quarter. Weekly sampling shows methane percentages above 2.5% in these probes: GMP-03, GMP-4S, TMP-1S, TMP-3M, and TMP-3S.

Probes Below 2.5% Methane

The following probes exhibited methane concentrations less than 2.5% threshold during the current quarterly monitoring period: GMP-01, GMP-02, GMP-4D, GMP-5D, GMP-5S, GMP-6D, GMP-6S, GMP-7D, GMP-7S, GMP-05, GMP-06, GMP-07, GMP-08, GMP-09, GMP-10, GMP-11, GMP-12, GMP-13D, GMP-13S, GMP-14D, GMP-14S, GMP-15D, GMP-15S, GMP-16D, GMP-16S, TMP-1D, TMP-1M, TMP-2D, TMP-2M, TMP-2S, TMP-3D, PZ-204A-SS and PZ-204-SS.

Quarterly-Read Probes

Sentry Probes currently monitored on a quarterly basis (measurements collected on 04/05/18) are GMP-05, GMP-06, and GMP-07. GMP-05, GMP-06 and GMP-07 exhibited methane concentrations below the 2.5% threshold. Sentry Probe GMP-04 was decommissioned in March 2014. Although Compliance Probe GMP-08 is listed as a quarterly-read probe, it was monitored more frequently during this monitoring period. It exhibited methane concentrations below the 2.5% threshold during this quarterly monitoring period.

Data Review

A review of the probe readings for this quarterly monitoring period indicates that the majority of the probes were in compliance for this quarterly monitoring period.

3.0 RECENT GAS MIGRATION CONTROL EFFORTS

The July 2013 CAP and subsequent quarterly updates provide an overview of several ongoing and planned measures that are expected to reduce gas migration. The following are gas migration control efforts initiated, continued or completed in the second quarter of 2018.

Leachate Conveyance System

The continued operation of multiple upgraded lift stations around the perimeter of the South Quarry.

General LFG System Modifications and Improvements:

The following improvements have been completed in the South Quarry at the Bridgeton Landfill:

- Installed ten (10) new landfill gas extraction wells in the south quarry. These wells were installed to increase the perimeter gas extraction capacity and liquid removal in each respective area. The locations were targeted to provide additional source control adjacent to areas displaying migration. Wells GEW-178, GEW-179, GEW-180, GEW-181, GEW-182, GEW-184, GEW-185, GEW-186, GEW-187, and GEW-188 were installed in December 2017. These ten landfill gas extraction wells have been connected to the gas collection and control system (see **Appendix D**).
- Continued operation and monitoring of the landfill gas extraction system adjacent to Metropolitan Sewer District lift station just southwest of the South Quarry. Any vapors extracted from this gravel sump are directed to a "Pure-Air" system of activated carbon to allow for direct atmospheric discharge, removing a large air source from the landfill's gas collection and control system (GCCS).
- Augmented gas well dewatering through use of additional down well pneumatic pumps and liquid levels monitoring. A systematic approach occurred this quarter to investigate all gas extraction wells in the southwest and southeast quadrants of the South Quarry to increase pumping and lower water levels.

Leachate Pretreatment Facility:

The leachate pretreatment facility continued operation during the second quarter of 2018.

4.0 PROPOSED AND ONGOING GAS MIGRATION CONTROL EFFORTS

Last year, BL had significant difficulty removing accumulated liquid in certain wells, thus rendering them less effective in terms of gas extraction. Landfill operations have continued landfill gas corrective action during this time through concentrated dewatering efforts of the gas extraction wells in the southwest and southeast quadrants of the South Quarry.

To enhance the above effort, BL installed ten (10) new gas extraction wells along the landfill perimeter close to the quarry wall, as discussed in Section 3.0. These gas extraction wells will continue to be operated.

BL continued to use various models of pneumatic pumps to reduce the liquid levels and expose well casing perforations in the GEWs. During this quarter, these dewatering efforts were tracked for the 10 gas wells installed during the fourth quarter of 2017. The liquid levels in those wells were reduced. BL will continue to monitor the liquid levels in these wells.

With the augmented dewatering efforts through optimization of day-to-day operations and maintenance efforts, BL continued to take weekly liquid levels and gas flow readings on the newly installed gas wells during the second quarter of 2018 to evaluate gas well dewatering efforts. This, coupled with the weekly analysis of South Quarry gas extraction well vacuum/flow, and gas concentrations in relative gas monitoring probes, provides insight as to gas collection efficiency in mitigation of subsurface perimeter gas migrations.

Gas monitoring probes GMP-4S and GMP-03, which are along the landfill east perimeter, and TMP-1S, TMP-3M, and TMP-3S, along the landfill southwest perimeter exhibited elevated concentrations of methane for at least a portion of the monitoring period. Gas monitoring probe GMP-4S experienced significant downward trends during the current monitoring period and was below the 2.5% threshold. GMP-4S has been in compliance since the May 15, 2018 reading. GMP-03 experienced a slight downward trend, however it was not below the 2.5% threshold.

Based on the above analysis, fourteen (14) new gas extraction wells will be installed during third quarter 2018 to increase gas collection efficiency. Ten (10) of the wells are located within the boundaries of the east side soil fill area completed in January 2018. The remaining four (4) wells are located in the South Quarry to enhance general gas extraction coverage. In addition, a significant soil fill project along the south side of the South Quarry is planned. This will involve reconfiguring the gas collection piping system, which will aid in increased liquid transfer and gas collection. Finally, the EVOH liner will be extended in the vicinity of GEW-1A to reduce infiltration and assist pumping efforts to improve gas collection efforts.

BL will continue augmented gas well dewatering efforts throughout the third quarter of 2018. This, coupled with the ongoing analysis of portions of the South Quarry gas extraction well vacuum, flow, and water levels, along with the installation of the new gas wells should provide timely remedies to maximize gas flows and mitigate perimeter gas migration.

5.0 CONTINUED MONITORING AND REPORTING

Bridgeton Landfill will continue with gas probe monitoring and reporting as specified in Section 5.0 of the July 2013 CAP.

TABLE 1

LIST OF LANDFILL GAS MONITORING PROBES

**Bridgeton Landfill
Landfill Gas Monitoring Probes
July 2013**

ID	CSV ID	POINT NAME	Ref Boring/installation Record	Type	Current Monitoring Frequency
GMP-01	BRIGMP01	MP01	GMP-01	Compliance probe	weekly
GMP-02	BRIGMP02	MP02	GMP-02	Compliance probe	weekly
GMP-03	BRIGMP03	MP03	GMP-03	Compliance probe	weekly
GMP-04*	BRIGMP04	MP04	GMP-04	Sentry probe	quarterly
GMP-05	BRIGMP05	MP05	GMP-05	Sentry probe	quarterly
GMP-06	BRIGMP06	MP06	PZ-201-SS	Sentry probe	quarterly
GMP-07	BRIGMP07	MP07	PZ-200-SS	Sentry probe	quarterly
GMP-08	BRIGMP08	MP08	GMP-08	Compliance probe	quarterly
GMP-09	BRIGMP09	MP09	GMP-09	Public Safety Probe	weekly
GMP-10	BRIGMP10	MP10	GMP-10	Public Safety Probe	weekly
GMP-11	BRIGMP11	MP11	GMP-11	Public Safety Probe	weekly
GMP-12	BRIGMP12	MP12	GMP-12	Public Safety Probe	weekly
GMP-4S	BRIGMP4S	BRIGMP4S	GMP-04	Compliance nested probe	weekly
GMP-4D	BRIGMP4D	BRIGMP4D	GMP-04	Compliance nested probe	weekly
GMP-5S	BRIGMP5S	BRIGMP5S	GMP-05	Compliance nested probe	weekly
GMP-5D	BRIGMP5D	BRIGMP5D	GMP-05	Compliance nested probe	weekly
GMP-6S	BRIGMP6S	BRIGMP6S	GMP-06	Compliance nested probe	weekly
GMP-6D	BRIGMP6D	BRIGMP6D	GMP-06	Compliance nested probe	weekly
GMP-7S	BRIGMP7S	BRIGMP7S	GMP-07	Compliance nested probe	weekly
GMP-7D	BRIGMP7D	BRIGMP7D	GMP-07	Compliance nested probe	weekly
GMP-13S	BRGMP13S	BRGMP13S	GMP-13	Compliance nested probe	weekly
GMP-13D	BRGMP13D	BRGMP13D	GMP-13	Compliance nested probe	weekly
GMP-14S	BRGMP14S	BRGMP14S	GMP-14	Compliance nested probe	weekly
GMP-14D	BRGMP14D	BRGMP14D	GMP-14	Compliance nested probe	weekly
GMP-15S	BRGMP15S	BRGMP15S	GMP-15	Compliance nested probe	weekly
GMP-15D	BRGMP15D	BRGMP15D	GMP-15	Compliance nested probe	weekly
GMP-16S	BRGMP16S	BRGMP16S	GMP-16	Compliance nested probe	weekly
GMP-16D	BRGMP16D	BRGMP16D	GMP-16	Compliance nested probe	weekly
TMP-1S	BRITMP1S	BRITMP1S	TMP-01	Investigative nested probe	weekly
TMP-1M	BRITMP1M	BRITMP1M	TMP-01	Investigative nested probe	weekly
TMP-1D	BRITMP1D	BRITMP1D	TMP-01	Investigative nested probe	weekly
TMP-2S	BRITMP2S	BRITMP2S	TMP-02	Investigative nested probe	weekly
TMP-2M	BRITMP2M	BRITMP2M	TMP-02	Investigative nested probe	weekly
TMP-2D	BRITMP2D	BRITMP2D	TMP-02	Investigative nested probe	weekly
TMP-3S	BRITMP3S	BRITMP3S	TMP-03	Investigative nested probe	weekly
TMP-3M	BRITMP3M	BRITMP3M	TMP-03	Investigative nested probe	weekly
TMP-3D	BRITMP3D	BRITMP3D	TMP-03	Investigative nested probe	weekly
PZ-204-SS	PZ2040SS	4OSS	PZ-204-SS	Public Safety Probe	weekly
PZ-204A-SS	PZ204ASS	4ASS	PZ-204-ASS	Public Safety Probe	weekly

* Well has been decommissioned

TABLE 2

COMPLIANCE GAS MONITORING PROBE DATA

MARCH 29, 2018 - JUNE 30, 2018

Point Name	Frequency	Quadrant	Record Date	CH ₄ (%)	CO ₂ (%)	O ₂ (%)	Balance Gas (%)	Barometric Pressure	Relative Pressure
GMP-01	Weekly	4	4/5/2018	0.0	0.1	20.2	79.7	30	-0.02
GMP-01	Weekly	4	4/11/2018	0.0	0.1	20.1	79.8	30	0.04
GMP-01	Weekly	4	4/17/2018	0.0	0.1	21.0	78.9	30	0.05
GMP-01	Weekly	4	4/24/2018	0.0	0.1	20.8	79.1	30	0.04
GMP-01	Weekly	4	4/30/2018	0.0	0.3	19.8	79.9	30	0.01
GMP-01	Weekly	4	5/8/2018	0.0	0.5	20.6	78.9	30	0.00
GMP-01	Weekly	4	5/15/2018	0.0	0.1	20.6	79.3	30	0.02
GMP-01	Weekly	4	5/23/2018	0.0	0.6	20.3	79.1	30	0.02
GMP-01	Weekly	4	5/30/2018	0.0	0.7	19.3	80.0	30	0.00
GMP-01	Weekly	4	6/5/2018	0.0	1.0	19.4	79.6	30	0.01
GMP-01	Weekly	4	6/13/2018	0.0	0.0	20.7	79.3	30	0.00
GMP-01	Weekly	4	6/19/2018	0.0	0.2	21.0	78.8	30	0.01
GMP-01	Weekly	4	6/27/2018	0.0	0.1	19.8	80.1	30	0.00
GMP-02	Weekly	4	4/5/2018	0.0	0.6	19.2	80.2	30	0.52
GMP-02	Weekly	4	4/11/2018	0.0	0.1	19.6	80.3	30	0.07
GMP-02	Weekly	4	4/17/2018	0.0	0.4	19.8	79.8	30	0.08
GMP-02	Weekly	4	4/24/2018	0.0	0.1	20.7	79.2	30	0.00
GMP-02	Weekly	4	4/30/2018	0.0	0.0	20.3	79.7	30	0.00
GMP-02	Weekly	4	5/8/2018	0.0	0.2	20.2	79.6	30	0.06
GMP-02	Weekly	4	5/15/2018	0.0	0.3	19.8	79.9	30	0.02
GMP-02	Weekly	4	5/23/2018	0.0	0.3	20.0	79.7	30	-0.01
GMP-02	Weekly	4	5/30/2018	0.0	0.3	19.9	79.8	30	0.00
GMP-02	Weekly	4	6/5/2018	0.0	0.2	20.1	79.7	30	-0.02
GMP-02	Weekly	4	6/13/2018	0.0	0.0	19.9	80.1	30	0.00
GMP-02	Weekly	4	6/19/2018	0.0	0.2	20.4	79.4	30	0.03
GMP-02	Weekly	4	6/27/2018	0.0	0.5	19.9	79.6	30	0.10
GMP-03	Weekly	4	4/5/2018	46.5	22.9	3.0	27.6	30	-0.05
GMP-03	Weekly	4	4/11/2018	58.1	28.0	2.2	11.7	30	0.02
GMP-03	Weekly	4	4/17/2018	67.7	29.5	0.0	2.8	30	0.03
GMP-03	Weekly	4	4/24/2018	67.3	31.6	0.0	1.1	30	0.04
GMP-03	Weekly	4	4/30/2018	18.5	7.5	14.8	59.2	30	0.01
GMP-03	Weekly	4	5/8/2018	63.8	32.1	0.0	4.1	30	0.03
GMP-03	Weekly	4	5/15/2018	61.2	32.0	0.1	6.7	30	0.02
GMP-03	Weekly	4	5/23/2018	58.1	30.9	0.7	10.3	30	0.03
GMP-03	Weekly	4	5/30/2018	59.3	33.3	0.0	7.4	30	0.03
GMP-03	Weekly	4	6/5/2018	57.1	33.0	0.2	9.7	30	0.03
GMP-03	Weekly	4	6/13/2018	57.1	36.9	0.1	5.9	30	0.03
GMP-03	Weekly	4	6/19/2018	53.1	34.3	0.2	12.4	30	0.02
GMP-03	Weekly	4	6/27/2018	51.7	34.5	0.3	13.5	30	0.01
GMP-08	Weekly	1	4/5/2018	0.0	7.2	9.6	83.2	30	0.05
GMP-08	Weekly	1	4/11/2018	0.0	1.4	12.8	85.8	30	0.01
GMP-08	Weekly	1	4/17/2018	0.0	3.2	11.1	85.7	30	0.01
GMP-08	Weekly	1	4/24/2018	0.0	5.5	11.0	83.5	30	0.00
GMP-08	Weekly	1	4/30/2018	0.0	0.0	20.0	80.0	30	0.02
GMP-08	Weekly	1	5/8/2018	0.0	2.2	15.0	82.8	30	-0.06
GMP-08	Weekly	1	5/15/2018	0.0	1.3	16.5	82.2	30	0.02

Point Name	Frequency	Quadrant	Record Date	CH ₄ (%)	CO ₂ (%)	O ₂ (%)	Balance Gas (%)	Barometric Pressure	Relative Pressure
GMP-08	Weekly	1	5/23/2018	0.0	2.4	15.1	82.5	30	0.02
GMP-08	Weekly	1	5/30/2018	0.0	5.0	12.0	83.0	30	0.00
GMP-08	Weekly	1	6/5/2018	0.0	4.2	12.8	83.0	30	0.01
GMP-08	Weekly	1	6/13/2018	0.0	1.5	16.6	81.9	30	-0.03
GMP-08	Weekly	1	6/19/2018	0.0	2.1	15.4	82.5	30	0.03
GMP-08	Weekly	1	6/27/2018	0.0	2.8	15.9	81.3	30	-0.01
GMP-4D	Weekly	3	4/5/2018	0.0	0.4	19.3	80.3	30	0.03
GMP-4D	Weekly	3	4/11/2018	0.0	0.2	19.6	80.2	30	-0.01
GMP-4D	Weekly	3	4/17/2018	0.0	0.0	15.6	84.4	30	0.10
GMP-4D	Weekly	3	4/24/2018	0.0	0.2	20.4	79.4	30	0.11
GMP-4D	Weekly	3	4/30/2018	0.5	0.0	20.1	79.4	30	0.01
GMP-4D	Weekly	3	5/8/2018	0.0	0.3	20.2	79.5	30	0.00
GMP-4D	Weekly	3	5/15/2018	0.0	0.2	20.1	79.7	30	0.05
GMP-4D	Weekly	3	5/23/2018	0.0	0.2	20.0	79.8	30	0.03
GMP-4D	Weekly	3	5/30/2018	0.0	0.1	20.0	79.9	30	0.02
GMP-4D	Weekly	3	6/5/2018	0.0	0.1	20.3	79.6	30	0.02
GMP-4D	Weekly	3	6/13/2018	0.0	0.1	20.9	79.0	30	0.02
GMP-4D	Weekly	3	6/19/2018	0.0	0.1	20.7	79.2	30	-0.03
GMP-4D	Weekly	3	6/27/2018	0.0	0.1	20.9	79.0	30	0.07
GMP-4S	Weekly	3	4/5/2018	9.4	1.3	15.6	73.7	30	0.02
GMP-4S	Weekly	3	4/11/2018	13.2	0.8	14.9	71.1	30	-0.01
GMP-4S	Weekly	3	4/17/2018	11.9	0.7	16.3	71.1	30	0.00
GMP-4S	Weekly	3	4/24/2018	13.9	0.8	16.0	69.3	30	0.02
GMP-4S	Weekly	3	4/30/2018	3.3	0.1	19.1	77.5	30	0.01
GMP-4S	Weekly	3	5/8/2018	12.0	1.3	15.9	70.8	30	0.00
GMP-4S	Weekly	3	5/15/2018	2.1	0.3	19.3	78.3	30	0.00
GMP-4S	Weekly	3	5/23/2018	1.6	0.4	18.8	79.2	30	-0.01
GMP-4S	Weekly	3	5/30/2018	1.7	0.4	19.1	78.8	30	0.00
GMP-4S	Weekly	3	6/5/2018	0.8	0.3	19.5	79.4	30	0.00
GMP-4S	Weekly	3	6/13/2018	0.8	0.3	19.7	79.2	30	0.00
GMP-4S	Weekly	3	6/19/2018	0.3	0.7	19.5	79.5	30	0.00
GMP-4S	Weekly	3	6/27/2018	0.0	0.5	20.0	79.5	30	0.00
GMP-5D	Weekly	3	4/5/2018	0.0	2.6	19.7	77.7	30	0.03
GMP-5D	Weekly	3	4/11/2018	0.0	0.9	19.3	79.8	30	0.00
GMP-5D	Weekly	3	4/17/2018	0.0	1.6	19.3	79.1	30	0.03
GMP-5D	Weekly	3	4/24/2018	0.0	1.5	19.9	78.6	30	0.03
GMP-5D	Weekly	3	4/30/2018	0.0	0.0	20.3	79.7	30	0.00
GMP-5D	Weekly	3	5/8/2018	0.0	1.5	19.5	79.0	30	-0.02
GMP-5D	Weekly	3	5/15/2018	0.0	1.3	19.1	79.6	30	0.02
GMP-5D	Weekly	3	5/23/2018	0.0	1.5	19.2	79.3	30	0.00
GMP-5D	Weekly	3	5/30/2018	0.0	1.1	19.5	79.4	30	0.02
GMP-5D	Weekly	3	6/5/2018	0.0	1.3	19.0	79.7	30	0.00
GMP-5D	Weekly	3	6/13/2018	0.0	0.8	19.6	79.6	30	0.01
GMP-5D	Weekly	3	6/19/2018	0.0	1.0	19.9	79.1	30	-0.01
GMP-5D	Weekly	3	6/27/2018	0.0	1.0	20.1	78.9	30	0.05
GMP-5S	Weekly	3	4/5/2018	0.0	3.2	14.8	82.0	30	0.69

Point Name	Frequency	Quadrant	Record Date	CH ₄ (%)	CO ₂ (%)	O ₂ (%)	Balance Gas (%)	Barometric Pressure	Relative Pressure
GMP-5S	Weekly	3	4/11/2018	0.0	0.9	15.6	83.5	30	-1.91
GMP-5S	Weekly	3	4/17/2018	0.0	2.6	14.9	82.5	30	0.95
GMP-5S	Weekly	3	4/24/2018	0.0	3.7	15.7	80.6	30	2.12
GMP-5S	Weekly	3	4/30/2018	0.0	0.0	20.2	79.8	30	0.02
GMP-5S	Weekly	3	5/8/2018	0.0	2.3	18.2	79.5	30	0.00
GMP-5S	Weekly	3	5/15/2018	0.0	1.8	18.9	79.3	30	0.02
GMP-5S	Weekly	3	5/23/2018	0.0	0.8	19.1	80.1	30	0.02
GMP-5S	Weekly	3	5/30/2018	0.0	0.8	19.5	79.7	30	0.00
GMP-5S	Weekly	3	6/5/2018	0.0	0.6	19.5	79.9	30	0.01
GMP-5S	Weekly	3	6/13/2018	0.0	0.3	20.1	79.6	30	0.00
GMP-5S	Weekly	3	6/19/2018	0.0	0.6	20.3	79.1	30	0.02
GMP-5S	Weekly	3	6/27/2018	0.0	1.1	20.1	78.8	30	0.02
GMP-6D	Weekly	3	4/5/2018	0.0	0.3	20.5	79.2	30	0.08
GMP-6D	Weekly	3	4/11/2018	0.0	0.1	19.6	80.3	30	-0.02
GMP-6D	Weekly	3	4/17/2018	0.0	0.1	20.0	79.9	30	0.02
GMP-6D	Weekly	3	4/24/2018	0.0	0.1	20.3	79.6	30	0.10
GMP-6D	Weekly	3	4/30/2018	0.0	0.0	20.4	79.6	30	0.01
GMP-6D	Weekly	3	5/8/2018	0.0	0.2	20.1	79.7	30	0.01
GMP-6D	Weekly	3	5/15/2018	0.0	0.2	19.9	79.9	30	0.04
GMP-6D	Weekly	3	5/23/2018	0.0	0.2	20.1	79.7	30	0.02
GMP-6D	Weekly	3	5/30/2018	0.0	0.1	20.2	79.7	30	0.00
GMP-6D	Weekly	3	6/5/2018	0.0	0.1	20.2	79.7	30	0.01
GMP-6D	Weekly	3	6/13/2018	0.0	0.0	20.8	79.2	30	-0.01
GMP-6D	Weekly	3	6/19/2018	0.0	0.1	20.9	79.0	30	0.01
GMP-6D	Weekly	3	6/27/2018	0.0	0.1	20.9	79.0	30	0.03
GMP-6S	Weekly	3	4/5/2018	0.0	0.7	19.6	79.7	30	0.04
GMP-6S	Weekly	3	4/11/2018	0.0	0.1	19.3	80.6	30	-0.02
GMP-6S	Weekly	3	4/17/2018	0.0	0.8	19.2	80.0	30	0.04
GMP-6S	Weekly	3	4/24/2018	0.0	0.3	20.0	79.7	30	0.06
GMP-6S	Weekly	3	4/30/2018	0.0	0.0	20.3	79.7	30	0.01
GMP-6S	Weekly	3	5/8/2018	0.0	0.3	19.8	79.9	30	0.04
GMP-6S	Weekly	3	5/15/2018	0.0	0.3	19.6	80.1	30	0.05
GMP-6S	Weekly	3	5/23/2018	0.0	0.5	19.6	79.9	30	0.04
GMP-6S	Weekly	3	5/30/2018	0.0	0.2	19.9	79.9	30	0.00
GMP-6S	Weekly	3	6/5/2018	0.0	0.1	20.1	79.8	30	0.01
GMP-6S	Weekly	3	6/13/2018	0.0	0.2	20.4	79.4	30	-0.01
GMP-6S	Weekly	3	6/19/2018	0.0	0.2	20.7	79.1	30	0.03
GMP-6S	Weekly	3	6/27/2018	0.0	0.2	20.6	79.2	30	0.03
GMP-7D	Weekly	1	4/5/2018	0.0	0.1	20.2	79.7	30	0.00
GMP-7D	Weekly	1	4/11/2018	0.0	0.1	19.9	80.0	30	0.00
GMP-7D	Weekly	1	4/17/2018	0.0	0.1	20.4	79.5	30	-0.01
GMP-7D	Weekly	1	4/24/2018	0.0	0.1	20.5	79.4	30	0.00
GMP-7D	Weekly	1	4/30/2018	0.0	0.0	20.1	79.9	30	0.00
GMP-7D	Weekly	1	5/8/2018	0.0	0.1	20.5	79.4	30	-0.04
GMP-7D	Weekly	1	5/15/2018	0.0	0.1	20.2	79.7	30	0.00
GMP-7D	Weekly	1	5/23/2018	0.0	0.1	20.4	79.5	30	0.00

Point Name	Frequency	Quadrant	Record Date	CH ₄ (%)	CO ₂ (%)	O ₂ (%)	Balance Gas (%)	Barometric Pressure	Relative Pressure
GMP-7D	Weekly	1	5/30/2018	0.0	0.1	20.3	79.6	30	0.00
GMP-7D	Weekly	1	6/5/2018	0.0	0.1	20.5	79.4	30	0.00
GMP-7D	Weekly	1	6/13/2018	0.0	0.2	20.6	79.2	30	-0.01
GMP-7D	Weekly	1	6/19/2018	0.0	0.1	21.1	78.8	30	0.00
GMP-7D	Weekly	1	6/27/2018	0.0	0.1	21.1	78.8	30	0.00
GMP-7S	Weekly	1	4/5/2018	0.0	0.3	9.9	89.8	30	-0.01
GMP-7S	Weekly	1	4/11/2018	0.0	1.3	11.2	87.5	30	0.00
GMP-7S	Weekly	1	4/17/2018	0.0	1.8	10.2	88.0	30	0.00
GMP-7S	Weekly	1	4/24/2018	0.0	1.4	11.3	87.3	30	0.00
GMP-7S	Weekly	1	4/30/2018	0.0	0.1	19.4	80.5	30	0.00
GMP-7S	Weekly	1	5/8/2018	0.0	1.4	10.9	87.7	30	-0.02
GMP-7S	Weekly	1	5/15/2018	0.0	1.9	11.3	86.8	30	0.01
GMP-7S	Weekly	1	5/23/2018	0.0	0.8	8.8	90.4	30	-0.01
GMP-7S	Weekly	1	5/30/2018	0.0	2.6	9.1	88.3	30	-0.01
GMP-7S	Weekly	1	6/5/2018	0.0	2.2	8.2	89.6	30	0.00
GMP-7S	Weekly	1	6/13/2018	0.0	1.2	8.5	90.3	30	-0.01
GMP-7S	Weekly	1	6/19/2018	0.0	2.5	8.7	88.8	30	0.01
GMP-7S	Weekly	1	6/27/2018	0.0	1.4	4.4	94.2	30	-0.01
GMP-13D	Weekly	3	4/5/2018	0.0	0.8	19.1	80.1	30	0.05
GMP-13D	Weekly	3	4/11/2018	0.0	0.4	19.5	80.1	30	0.01
GMP-13D	Weekly	3	4/17/2018	0.0	0.4	19.8	79.8	30	0.04
GMP-13D	Weekly	3	4/24/2018	0.0	0.4	20.5	79.1	30	0.02
GMP-13D	Weekly	3	4/30/2018	0.0	0.1	20.0	79.9	30	0.01
GMP-13D	Weekly	3	5/8/2018	0.0	0.3	20.2	79.5	30	0.01
GMP-13D	Weekly	3	5/15/2018	0.0	0.4	19.9	79.7	30	0.00
GMP-13D	Weekly	3	5/23/2018	0.0	0.4	20.0	79.6	30	0.02
GMP-13D	Weekly	3	5/30/2018	0.0	0.4	20.1	79.5	30	0.01
GMP-13D	Weekly	3	6/5/2018	0.0	0.3	20.3	79.4	30	-0.01
GMP-13D	Weekly	3	6/13/2018	0.0	0.3	20.8	78.9	30	0.01
GMP-13D	Weekly	3	6/19/2018	0.0	0.2	20.8	79.0	30	-0.01
GMP-13D	Weekly	3	6/27/2018	0.0	0.1	21.0	78.9	30	0.00
GMP-13S	Weekly	3	4/5/2018	0.0	2.0	14.5	83.5	30	-0.01
GMP-13S	Weekly	3	4/11/2018	0.0	0.7	16.2	83.1	30	0.00
GMP-13S	Weekly	3	4/17/2018	0.0	1.3	15.0	83.7	30	0.01
GMP-13S	Weekly	3	4/24/2018	0.0	1.7	16.1	82.2	30	0.00
GMP-13S	Weekly	3	4/30/2018	0.1	0.3	19.5	80.1	30	0.01
GMP-13S	Weekly	3	5/8/2018	0.1	2.6	15.2	82.1	30	0.00
GMP-13S	Weekly	3	5/15/2018	0.0	2.9	14.7	82.4	30	0.00
GMP-13S	Weekly	3	5/23/2018	0.0	3.5	14.0	82.5	30	0.00
GMP-13S	Weekly	3	5/30/2018	0.0	3.9	13.3	82.8	30	-0.01
GMP-13S	Weekly	3	6/5/2018	0.0	4.3	13.1	82.6	30	-0.02
GMP-13S	Weekly	3	6/13/2018	0.0	4.7	13.5	81.8	30	-0.01
GMP-13S	Weekly	3	6/19/2018	0.1	4.8	13.3	81.8	30	-0.01
GMP-13S	Weekly	3	6/27/2018	0.0	5.0	13.1	81.9	30	-0.01
GMP-14D	Weekly	3	4/5/2018	0.0	0.6	19.2	80.2	30	0.03
GMP-14D	Weekly	3	4/11/2018	0.0	0.2	19.4	80.4	30	-0.03

Point Name	Frequency	Quadrant	Record Date	CH ₄ (%)	CO ₂ (%)	O ₂ (%)	Balance Gas (%)	Barometric Pressure	Relative Pressure
GMP-14D	Weekly	3	4/17/2018	0.0	0.2	19.9	79.9	30	0.02
GMP-14D	Weekly	3	4/24/2018	0.0	0.1	20.6	79.3	30	0.01
GMP-14D	Weekly	3	4/30/2018	0.0	0.0	20.2	79.8	30	0.01
GMP-14D	Weekly	3	5/8/2018	0.0	0.1	20.2	79.7	30	0.03
GMP-14D	Weekly	3	5/15/2018	0.0	0.1	20.1	79.8	30	0.01
GMP-14D	Weekly	3	5/23/2018	0.0	0.1	20.0	79.9	30	0.04
GMP-14D	Weekly	3	5/30/2018	0.0	0.1	20.2	79.7	30	-0.04
GMP-14D	Weekly	3	6/5/2018	0.0	0.0	20.3	79.7	30	0.01
GMP-14D	Weekly	3	6/13/2018	0.0	0.0	20.8	79.2	30	0.03
GMP-14D	Weekly	3	6/19/2018	0.0	0.0	20.9	79.1	30	-0.02
GMP-14D	Weekly	3	6/27/2018	0.0	0.0	20.9	79.1	30	0.00
GMP-14S	Weekly	3	4/5/2018	0.0	0.3	19.3	80.4	30	0.01
GMP-14S	Weekly	3	4/11/2018	0.0	0.1	19.7	80.2	30	-0.03
GMP-14S	Weekly	3	4/17/2018	0.0	0.2	19.9	79.9	30	0.01
GMP-14S	Weekly	3	4/24/2018	0.0	0.1	20.6	79.3	30	0.00
GMP-14S	Weekly	3	4/30/2018	0.0	0.0	20.2	79.8	30	0.03
GMP-14S	Weekly	3	5/8/2018	0.0	0.2	20.2	79.6	30	0.00
GMP-14S	Weekly	3	5/15/2018	0.0	0.1	20.2	79.7	30	0.01
GMP-14S	Weekly	3	5/23/2018	0.0	0.1	20.0	79.9	30	0.00
GMP-14S	Weekly	3	5/30/2018	0.0	0.0	20.3	79.7	30	-0.01
GMP-14S	Weekly	3	6/5/2018	0.0	0.1	20.2	79.7	30	0.00
GMP-14S	Weekly	3	6/13/2018	0.0	0.0	20.8	79.2	30	0.00
GMP-14S	Weekly	3	6/19/2018	0.0	0.0	20.9	79.1	30	-0.02
GMP-14S	Weekly	3	6/27/2018	0.0	0.0	21.0	79.0	30	0.01
GMP-15D	Weekly	2	4/5/2018	0.0	0.2	20.7	79.1	30	0.03
GMP-15D	Weekly	2	4/11/2018	0.0	0.0	19.8	80.2	30	0.02
GMP-15D	Weekly	2	4/17/2018	0.0	0.2	20.0	79.8	30	0.01
GMP-15D	Weekly	2	4/24/2018	0.0	0.3	20.2	79.5	30	0.10
GMP-15D	Weekly	2	4/30/2018	0.0	0.0	20.4	79.6	30	0.01
GMP-15D	Weekly	2	5/8/2018	0.0	0.6	20.0	79.4	30	0.03
GMP-15D	Weekly	2	5/15/2018	0.0	0.5	19.7	79.8	30	0.15
GMP-15D	Weekly	2	5/23/2018	0.0	0.4	20.0	79.6	30	0.03
GMP-15D	Weekly	2	5/30/2018	0.0	0.2	20.1	79.7	30	0.02
GMP-15D	Weekly	2	6/5/2018	0.0	0.3	20.2	79.5	30	0.04
GMP-15D	Weekly	2	6/13/2018	0.0	0.0	20.8	79.2	30	-0.02
GMP-15D	Weekly	2	6/19/2018	0.0	0.3	20.7	79.0	30	0.02
GMP-15D	Weekly	2	6/27/2018	0.0	0.2	20.7	79.1	30	0.05
GMP-15S	Weekly	2	4/5/2018	0.0	0.2	20.7	79.1	30	-0.01
GMP-15S	Weekly	2	4/11/2018	0.0	0.1	19.7	80.2	30	-0.03
GMP-15S	Weekly	2	4/17/2018	0.0	0.1	20.0	79.9	30	-0.01
GMP-15S	Weekly	2	4/24/2018	0.0	0.1	20.3	79.6	30	0.03
GMP-15S	Weekly	2	4/30/2018	0.0	0.0	20.2	79.8	30	0.00
GMP-15S	Weekly	2	5/8/2018	0.0	0.1	20.3	79.6	30	0.02
GMP-15S	Weekly	2	5/15/2018	0.0	0.1	20.1	79.8	30	0.04
GMP-15S	Weekly	2	5/23/2018	0.0	0.1	20.3	79.6	30	0.02
GMP-15S	Weekly	2	5/30/2018	0.0	0.1	20.3	79.6	30	0.02

Point Name	Frequency	Quadrant	Record Date	CH ₄ (%)	CO ₂ (%)	O ₂ (%)	Balance Gas (%)	Barometric Pressure	Relative Pressure
GMP-15S	Weekly	2	6/5/2018	0.0	0.0	20.4	79.6	30	0.03
GMP-15S	Weekly	2	6/13/2018	0.0	0.0	20.9	79.1	30	-0.04
GMP-15S	Weekly	2	6/19/2018	0.0	0.0	20.9	79.1	30	0.04
GMP-15S	Weekly	2	6/27/2018	0.0	0.0	21.0	79.0	30	0.01
GMP-16D	Weekly	1	4/5/2018	0.0	0.4	19.7	79.9	30	0.03
GMP-16D	Weekly	1	4/11/2018	0.0	0.3	19.2	80.5	30	0.04
GMP-16D	Weekly	1	4/17/2018	0.0	1.1	19.4	79.5	30	0.10
GMP-16D	Weekly	1	4/24/2018	0.0	1.8	17.2	81.0	30	0.16
GMP-16D	Weekly	1	4/30/2018	0.0	0.4	18.7	80.9	30	0.01
GMP-16D	Weekly	1	5/8/2018	0.0	2.9	15.7	81.4	30	0.07
GMP-16D	Weekly	1	5/15/2018	0.0	3.0	15.0	82.0	30	0.05
GMP-16D	Weekly	1	5/23/2018	0.0	3.8	14.1	82.1	30	0.08
GMP-16D	Weekly	1	5/30/2018	0.0	3.8	13.6	82.6	30	0.08
GMP-16D	Weekly	1	6/5/2018	0.0	4.5	13.0	82.5	30	-0.10
GMP-16D	Weekly	1	6/13/2018	0.0	2.4	13.6	84.0	30	0.01
GMP-16D	Weekly	1	6/19/2018	0.0	4.6	13.4	82.0	30	0.06
GMP-16D	Weekly	1	6/27/2018	0.0	6.5	10.9	82.6	30	0.01
GMP-16S	Weekly	1	4/5/2018	0.0	0.1	20.0	79.9	30	0.02
GMP-16S	Weekly	1	4/11/2018	0.0	0.0	19.6	80.4	30	-0.05
GMP-16S	Weekly	1	4/17/2018	0.0	0.1	20.1	79.8	30	0.07
GMP-16S	Weekly	1	4/24/2018	0.0	0.1	20.2	79.7	30	0.02
GMP-16S	Weekly	1	4/30/2018	0.0	0.1	20.0	79.9	30	0.00
GMP-16S	Weekly	1	5/8/2018	0.0	0.2	20.2	79.6	30	0.00
GMP-16S	Weekly	1	5/15/2018	0.0	0.1	19.9	80.0	30	0.01
GMP-16S	Weekly	1	5/23/2018	0.0	0.1	20.0	79.9	30	-0.02
GMP-16S	Weekly	1	5/30/2018	0.0	0.1	20.0	79.9	30	0.00
GMP-16S	Weekly	1	6/5/2018	0.0	0.1	20.1	79.8	30	0.02
GMP-16S	Weekly	1	6/13/2018	0.0	0.0	20.8	79.2	30	0.00
GMP-16S	Weekly	1	6/19/2018	0.0	0.0	21.0	79.0	30	-0.02
GMP-16S	Weekly	1	6/27/2018	0.0	0.0	20.9	79.1	30	2.39

TABLE 3

SENTRY GAS MONITORING PROBE DATA

MARCH 29, 2018 - JUNE 30, 2018

Point Name	Frequency	Quadrant	Record Date	CH ₄ (%)	CO ₂ (%)	O ₂ (%)	Balance Gas (%)	Barometric Pressure	Relative Pressure
GMP-05	Quarterly	3	4/5/2018	0.2	0.2	20.2	79.4	30	0.11
GMP-06	Quarterly	3	4/5/2018	0.0	0.4	20.0	79.6	30	0.00
GMP-07	Quarterly	1	4/5/2018	0.0	0.3	20.0	79.7	30	0.00

TABLE 4

INVESTIGATIVE GAS MONITORING PROBE DATA

MARCH 29, 2018 – JUNE 30, 2018

Point Name	Frequency	Quadrant	Record Date	CH ₄ (%)	CO ₂ (%)	O ₂ (%)	Balance Gas (%)	Barometric Pressure	Relative Pressure
TMP-1D	Weekly	4	4/5/2018	0.0	0.4	20.0	79.6	30	0.79
TMP-1D	Weekly	4	4/11/2018	0.0	0.1	20.2	79.7	30	1.27
TMP-1D	Weekly	4	4/17/2018	0.0	0.1	20.9	79.0	30	1.11
TMP-1D	Weekly	4	4/24/2018	0.0	0.1	21.2	78.7	30	1.33
TMP-1D	Weekly	4	4/30/2018	0.0	0.3	20.2	79.5	30	0.03
TMP-1D	Weekly	4	5/8/2018	0.1	0.1	20.7	79.1	30	1.54
TMP-1D	Weekly	4	5/15/2018	0.0	0.1	20.8	79.1	30	1.09
TMP-1D	Weekly	4	5/23/2018	0.0	0.2	20.5	79.3	30	1.31
TMP-1D	Weekly	4	5/30/2018	0.0	0.1	20.6	79.3	30	1.41
TMP-1D	Weekly	4	6/5/2018	0.0	0.1	20.7	79.2	30	1.50
TMP-1D	Weekly	4	6/13/2018	0.0	0.1	20.7	79.2	30	0.82
TMP-1D	Weekly	4	6/19/2018	0.0	0.2	21.0	78.8	30	1.31
TMP-1D	Weekly	4	6/27/2018	0.1	0.1	20.7	79.1	30	1.11
TMP-1M	Weekly	4	4/5/2018	0.0	1.9	19.8	78.3	30	-0.03
TMP-1M	Weekly	4	4/11/2018	0.0	0.2	20.4	79.4	30	-0.03
TMP-1M	Weekly	4	4/17/2018	0.0	0.4	20.9	78.7	30	-0.03
TMP-1M	Weekly	4	4/24/2018	0.0	0.2	21.2	78.6	30	-0.03
TMP-1M	Weekly	4	4/30/2018	0.0	1.5	19.9	78.6	30	-0.03
TMP-1M	Weekly	4	5/8/2018	0.1	0.1	20.9	78.9	30	-0.02
TMP-1M	Weekly	4	5/15/2018	0.1	0.1	20.9	78.9	30	-0.01
TMP-1M	Weekly	4	5/23/2018	0.0	0.1	20.7	79.2	30	-0.01
TMP-1M	Weekly	4	5/30/2018	0.0	0.2	20.7	79.1	30	-0.06
TMP-1M	Weekly	4	6/5/2018	0.1	0.1	20.8	79.0	30	-0.01
TMP-1M	Weekly	4	6/13/2018	0.0	0.1	20.8	79.1	30	-0.50
TMP-1M	Weekly	4	6/19/2018	0.0	0.2	21.1	78.7	30	0.00
TMP-1M	Weekly	4	6/27/2018	0.1	0.1	21.0	78.8	30	-0.01
TMP-1S	Weekly	4	4/5/2018	58.2	32.6	1.2	8.0	30	0.25
TMP-1S	Weekly	4	4/11/2018	60.6	35.9	0.5	3.0	30	0.03
TMP-1S	Weekly	4	4/17/2018	61.8	34.7	0.5	3.0	30	0.14
TMP-1S	Weekly	4	4/24/2018	62.6	35.1	0.3	2.0	30	0.07
TMP-1S	Weekly	4	4/30/2018	57.3	28.3	3.0	11.4	30	0.06
TMP-1S	Weekly	4	5/8/2018	61.1	35.8	0.0	3.1	30	0.11
TMP-1S	Weekly	4	5/15/2018	60.3	36.9	0.1	2.7	30	0.08
TMP-1S	Weekly	4	5/23/2018	58.7	36.5	0.4	4.4	30	0.10
TMP-1S	Weekly	4	5/30/2018	59.7	37.2	0.3	2.8	30	0.03
TMP-1S	Weekly	4	6/5/2018	60.9	35.2	0.2	3.7	30	0.04
TMP-1S	Weekly	4	6/13/2018	61.0	37.9	0.2	0.9	30	0.03
TMP-1S	Weekly	4	6/19/2018	60.1	36.5	0.2	3.2	30	0.04
TMP-1S	Weekly	4	6/27/2018	60.4	37.3	0.2	2.1	30	0.04
TMP-2D	Weekly	4	4/5/2018	0.0	0.6	20.1	79.3	30	0.11
TMP-2D	Weekly	4	4/11/2018	0.0	0.3	20.0	79.7	30	0.18
TMP-2D	Weekly	4	4/17/2018	0.0	0.2	20.9	78.9	30	0.15
TMP-2D	Weekly	4	4/24/2018	0.0	0.2	21.1	78.7	30	0.00
TMP-2D	Weekly	4	4/30/2018	0.0	1.6	19.8	78.6	30	0.00
TMP-2D	Weekly	4	5/8/2018	0.0	0.2	20.7	79.1	30	0.00
TMP-2D	Weekly	4	5/15/2018	0.1	0.1	20.6	79.2	30	0.00

Point Name	Frequency	Quadrant	Record Date	CH ₄ (%)	CO ₂ (%)	O ₂ (%)	Balance Gas (%)	Barometric Pressure	Relative Pressure
TMP-2D	Weekly	4	5/23/2018	0.1	0.1	20.6	79.2	30	0.02
TMP-2D	Weekly	4	5/30/2018	0.0	0.4	20.5	79.1	30	0.00
TMP-2D	Weekly	4	6/5/2018	0.0	0.2	20.8	79.0	30	0.00
TMP-2D	Weekly	4	6/13/2018	0.0	0.7	20.8	78.5	30	0.01
TMP-2D	Weekly	4	6/19/2018	0.0	0.2	21.0	78.8	30	0.01
TMP-2D	Weekly	4	6/27/2018	0.0	0.1	20.2	79.7	30	0.00
TMP-2M	Weekly	4	4/5/2018	0.2	0.7	19.8	79.3	30	0.02
TMP-2M	Weekly	4	4/11/2018	0.5	0.7	19.5	79.3	30	0.00
TMP-2M	Weekly	4	4/17/2018	0.0	0.2	20.8	79.0	30	0.00
TMP-2M	Weekly	4	4/24/2018	0.0	0.9	20.6	78.5	30	-0.08
TMP-2M	Weekly	4	4/30/2018	0.4	4.2	15.0	80.4	30	-0.02
TMP-2M	Weekly	4	5/8/2018	0.5	9.8	9.5	80.2	30	-0.01
TMP-2M	Weekly	4	5/15/2018	0.5	9.3	10.6	79.6	30	0.00
TMP-2M	Weekly	4	5/23/2018	1.4	8.8	11.9	77.9	30	-0.01
TMP-2M	Weekly	4	5/30/2018	1.6	12.2	9.0	77.2	30	0.00
TMP-2M	Weekly	4	6/5/2018	1.9	15.0	6.5	76.6	30	0.00
TMP-2M	Weekly	4	6/13/2018	0.9	8.5	12.2	78.4	30	0.00
TMP-2M	Weekly	4	6/19/2018	1.5	14.3	7.9	76.3	30	0.00
TMP-2M	Weekly	4	6/27/2018	1.2	11.1	10.1	77.6	30	-0.01
TMP-2S	Weekly	4	4/5/2018	0.0	3.9	10.5	85.6	30	0.00
TMP-2S	Weekly	4	4/11/2018	0.0	4.6	9.6	85.8	30	0.01
TMP-2S	Weekly	4	4/17/2018	0.0	2.8	12.4	84.8	30	0.00
TMP-2S	Weekly	4	4/24/2018	0.0	2.4	13.3	84.3	30	0.00
TMP-2S	Weekly	4	4/30/2018	0.0	2.1	16.6	81.3	30	0.01
TMP-2S	Weekly	4	5/8/2018	0.0	5.5	12.3	82.2	30	-0.01
TMP-2S	Weekly	4	5/15/2018	0.0	9.5	9.1	81.4	30	0.00
TMP-2S	Weekly	4	5/23/2018	0.0	5.6	12.4	82.0	30	0.00
TMP-2S	Weekly	4	5/30/2018	0.0	6.9	11.6	81.5	30	0.00
TMP-2S	Weekly	4	6/5/2018	0.0	6.7	11.9	81.4	30	0.00
TMP-2S	Weekly	4	6/13/2018	0.0	6.9	11.6	81.5	30	0.00
TMP-2S	Weekly	4	6/19/2018	0.0	10.2	10.6	79.2	30	0.01
TMP-2S	Weekly	4	6/27/2018	0.0	7.5	12.3	80.2	30	-0.01
TMP-3D	Weekly	4	4/5/2018	0.0	1.2	20.2	78.6	30	0.16
TMP-3D	Weekly	4	4/11/2018	0.0	0.3	20.3	79.4	30	0.00
TMP-3D	Weekly	4	4/17/2018	0.0	0.1	21.0	78.9	30	0.00
TMP-3D	Weekly	4	4/24/2018	0.2	1.2	19.2	79.4	30	-0.35
TMP-3D	Weekly	4	4/30/2018	0.0	1.0	19.5	79.5	30	0.11
TMP-3D	Weekly	4	5/8/2018	0.2	1.5	19.1	79.2	30	-0.06
TMP-3D	Weekly	4	5/15/2018	0.1	0.9	19.8	79.2	30	-0.41
TMP-3D	Weekly	4	5/23/2018	0.2	2.3	18.4	79.1	30	-0.16
TMP-3D	Weekly	4	5/30/2018	0.0	1.1	19.3	79.6	30	0.05
TMP-3D	Weekly	4	6/5/2018	0.0	2.2	18.7	79.1	30	0.09
TMP-3D	Weekly	4	6/13/2018	0.0	1.3	19.5	79.2	30	-0.29
TMP-3D	Weekly	4	6/19/2018	0.0	1.0	20.1	78.9	30	0.11
TMP-3D	Weekly	4	6/27/2018	0.2	2.9	17.8	79.1	30	-0.23
TMP-3M	Weekly	4	4/5/2018	17.3	21.2	12.4	49.1	30	-0.24

Point Name	Frequency	Quadrant	Record Date	CH ₄ (%)	CO ₂ (%)	O ₂ (%)	Balance Gas (%)	Barometric Pressure	Relative Pressure
TMP-3M	Weekly	4	4/11/2018	27.5	36.1	7.2	29.2	30	-0.92
TMP-3M	Weekly	4	4/17/2018	3.2	5.6	19.2	72.0	30	0.07
TMP-3M	Weekly	4	4/24/2018	2.1	3.3	20.0	74.6	30	-0.01
TMP-3M	Weekly	4	4/30/2018	1.4	3.6	19.1	75.9	30	0.03
TMP-3M	Weekly	4	5/8/2018	8.3	13.8	16.4	61.5	30	0.09
TMP-3M	Weekly	4	5/15/2018	7.8	13.2	16.8	62.2	30	0.02
TMP-3M	Weekly	4	5/23/2018	4.4	8.1	18.3	69.2	30	-0.01
TMP-3M	Weekly	4	5/30/2018	3.7	7.6	18.7	70.0	30	-0.01
TMP-3M	Weekly	4	6/5/2018	4.5	8.2	18.3	69.0	30	0.05
TMP-3M	Weekly	4	6/13/2018	6.5	11.8	17.6	64.1	30	-0.02
TMP-3M	Weekly	4	6/19/2018	6.6	11.6	17.6	64.2	30	0.07
TMP-3M	Weekly	4	6/27/2018	6.9	10.9	17.3	64.9	30	0.02
TMP-3S	Weekly	4	4/5/2018	4.8	1.5	19.2	74.5	30	0.01
TMP-3S	Weekly	4	4/11/2018	6.2	0.9	18.7	74.2	30	0.00
TMP-3S	Weekly	4	4/17/2018	4.0	0.5	19.9	75.6	30	0.00
TMP-3S	Weekly	4	4/24/2018	37.6	5.9	9.6	46.9	30	0.02
TMP-3S	Weekly	4	4/30/2018	22.9	3.4	13.4	60.3	30	0.03
TMP-3S	Weekly	4	5/8/2018	28.7	11.0	11.7	48.6	30	0.00
TMP-3S	Weekly	4	5/15/2018	40.5	16.2	8.6	34.7	30	0.22
TMP-3S	Weekly	4	5/23/2018	43.9	25.7	6.2	24.2	30	0.48
TMP-3S	Weekly	4	5/30/2018	45.1	28.7	5.4	20.8	30	0.40
TMP-3S	Weekly	4	6/5/2018	39.1	24.1	7.7	29.1	30	0.43
TMP-3S	Weekly	4	6/13/2018	50.5	31.2	4.3	14.0	30	0.43
TMP-3S	Weekly	4	6/19/2018	50.4	30.8	3.9	14.9	30	0.47
TMP-3S	Weekly	4	6/27/2018	49.5	30.7	4.3	15.5	30	0.51

TABLE 5

PUBLIC SAFETY GAS MONITORING PROBE DATA

MARCH 29, 2018 – JUNE 30, 2018

Point Name	Frequency	Quadrant	Record Date	CH ₄ (%)	CO ₂ (%)	O ₂ (%)	Balance Gas (%)	Barometric Pressure	Relative Pressure
4ASS	Weekly	4	4/5/2018	0.0	0.4	19.8	79.8	30	0.06
4ASS	Weekly	4	4/11/2018	0.0	0.1	19.9	80.0	30	0.01
4ASS	Weekly	4	4/17/2018	0.0	0.3	20.3	79.4	30	-0.60
4ASS	Weekly	4	4/24/2018	0.0	0.3	20.5	79.2	30	0.05
4ASS	Weekly	4	4/30/2018	0.0	0.0	19.9	80.1	30	0.02
4ASS	Weekly	4	5/8/2018	0.0	0.0	20.6	79.4	30	-0.04
4ASS	Weekly	4	5/15/2018	0.0	0.1	20.4	79.5	30	0.00
4ASS	Weekly	4	5/23/2018	0.0	0.1	20.4	79.5	30	0.00
4ASS	Weekly	4	5/30/2018	0.0	0.0	20.5	79.5	30	0.00
4ASS	Weekly	4	6/5/2018	0.0	0.0	20.6	79.4	30	0.00
4ASS	Weekly	4	6/13/2018	0.0	0.2	20.2	79.6	30	0.00
4ASS	Weekly	4	6/19/2018	0.0	0.1	21.0	78.9	30	0.00
4ASS	Weekly	4	6/27/2018	0.0	0.5	20.1	79.4	30	0.78
4OSS	Weekly	4	4/5/2018	0.0	0.2	20.0	79.8	30	-0.01
4OSS	Weekly	4	4/11/2018	0.0	0.0	19.9	80.1	30	1.24
4OSS	Weekly	4	4/17/2018	0.0	0.1	20.8	79.1	30	0.00
4OSS	Weekly	4	4/24/2018	0.0	0.1	21.0	78.9	30	0.01
4OSS	Weekly	4	4/30/2018	0.0	0.0	19.9	80.1	30	0.00
4OSS	Weekly	4	5/8/2018	0.0	0.0	20.7	79.3	30	0.00
4OSS	Weekly	4	5/15/2018	0.0	0.0	20.4	79.6	30	0.01
4OSS	Weekly	4	5/23/2018	0.0	0.0	20.5	79.5	30	0.00
4OSS	Weekly	4	5/30/2018	0.0	0.0	20.5	79.5	30	0.01
4OSS	Weekly	4	6/5/2018	0.0	0.0	20.6	79.4	30	0.06
4OSS	Weekly	4	6/13/2018	0.0	0.0	20.4	79.6	30	0.00
4OSS	Weekly	4	6/19/2018	0.0	0.0	21.1	78.9	30	0.04
4OSS	Weekly	4	6/27/2018	0.0	0.1	20.4	79.5	30	-0.33
GMP-09	Weekly	4	4/5/2018	0.0	11.6	14.4	74.0	30	2.60
GMP-09	Weekly	4	4/11/2018	0.0	9.7	14.2	76.1	30	-0.01
GMP-09	Weekly	4	4/17/2018	0.0	1.6	18.3	80.1	30	0.26
GMP-09	Weekly	4	4/24/2018	0.0	1.9	19.5	78.6	30	0.06
GMP-09	Weekly	4	4/30/2018	0.0	0.5	19.7	79.8	30	0.02
GMP-09	Weekly	4	5/8/2018	0.0	1.6	19.4	79.0	30	0.05
GMP-09	Weekly	4	5/15/2018	0.0	0.5	19.6	79.9	30	0.07
GMP-09	Weekly	4	5/23/2018	0.0	0.7	19.5	79.8	30	0.04
GMP-09	Weekly	4	5/30/2018	0.0	1.1	19.1	79.8	30	0.02
GMP-09	Weekly	4	6/5/2018	0.0	2.4	18.2	79.4	30	0.72
GMP-09	Weekly	4	6/13/2018	0.0	15.2	7.2	77.6	30	0.05
GMP-09	Weekly	4	6/19/2018	2.0	14.7	14.1	69.2	30	0.16
GMP-09	Weekly	4	6/27/2018	2.1	6.8	16.8	74.3	30	9.05
GMP-10	Weekly	4	4/5/2018	0.0	2.8	13.3	83.9	30	-3.24
GMP-10	Weekly	4	4/11/2018	0.0	0.5	19.0	80.5	30	0.03
GMP-10	Weekly	4	4/17/2018	0.0	1.0	19.2	79.8	30	1.81
GMP-10	Weekly	4	4/24/2018	0.0	0.6	20.1	79.3	30	-2.33
GMP-10	Weekly	4	4/30/2018	0.0	0.1	19.8	80.1	30	0.01
GMP-10	Weekly	4	5/8/2018	0.0	0.2	20.2	79.6	30	0.02
GMP-10	Weekly	4	5/15/2018	0.0	0.3	20.3	79.4	30	0.02

Point Name	Frequency	Quadrant	Record Date	CH ₄ (%)	CO ₂ (%)	O ₂ (%)	Balance Gas (%)	Barometric Pressure	Relative Pressure
GMP-10	Weekly	4	5/23/2018	0.0	0.4	20.1	79.5	30	0.15
GMP-10	Weekly	4	5/30/2018	0.0	0.2	20.2	79.6	30	0.13
GMP-10	Weekly	4	6/5/2018	0.0	0.2	20.5	79.3	30	0.01
GMP-10	Weekly	4	6/13/2018	0.0	0.7	20.2	79.1	30	0.02
GMP-10	Weekly	4	6/19/2018	0.0	0.2	21.1	78.7	30	0.00
GMP-10	Weekly	4	6/27/2018	0.0	1.6	19.1	79.3	30	0.50
GMP-11	Weekly	4	4/5/2018	0.0	0.7	19.9	79.4	30	3.88
GMP-11	Weekly	4	4/11/2018	0.3	1.1	19.7	78.9	30	8.75
GMP-11	Weekly	4	4/17/2018	1.0	1.6	20.0	77.4	30	8.75
GMP-11	Weekly	4	4/24/2018	1.3	0.5	20.6	77.6	30	4.17
GMP-11	Weekly	4	4/30/2018	0.0	0.7	19.6	79.7	30	0.10
GMP-11	Weekly	4	5/8/2018	0.0	0.2	20.5	79.3	30	0.04
GMP-11	Weekly	4	5/15/2018	1.1	0.4	19.9	78.6	30	0.37
GMP-11	Weekly	4	5/23/2018	0.2	0.8	20.1	78.9	30	7.84
GMP-11	Weekly	4	5/30/2018	1.0	0.3	20.0	78.7	30	0.27
GMP-11	Weekly	4	6/5/2018	0.9	0.3	20.2	78.6	30	0.19
GMP-11	Weekly	4	6/13/2018	0.0	0.0	20.3	79.7	30	0.00
GMP-11	Weekly	4	6/19/2018	2.2	0.5	20.3	77.0	30	3.88
GMP-11	Weekly	4	6/27/2018	0.8	4.3	19.6	75.3	30	3.53
GMP-12	Weekly	4	4/5/2018	0.0	0.1	20.0	79.9	30	0.65
GMP-12	Weekly	4	4/11/2018	0.0	0.2	19.8	80.0	30	0.53
GMP-12	Weekly	4	4/17/2018	0.0	0.3	20.3	79.4	30	0.71
GMP-12	Weekly	4	4/24/2018	0.0	0.1	20.8	79.1	30	-0.05
GMP-12	Weekly	4	4/30/2018	0.0	0.1	19.7	80.2	30	-1.53
GMP-12	Weekly	4	5/8/2018	0.0	0.1	20.6	79.3	30	0.00
GMP-12	Weekly	4	5/15/2018	0.0	0.1	20.1	79.8	30	-4.35
GMP-12	Weekly	4	5/23/2018	0.4	0.7	19.7	79.2	30	-0.86
GMP-12	Weekly	4	5/30/2018	0.0	0.3	20.0	79.7	30	-4.28
GMP-12	Weekly	4	6/5/2018	0.8	0.3	19.8	79.1	30	-2.64
GMP-12	Weekly	4	6/13/2018	0.0	0.0	19.9	80.1	30	0.11
GMP-12	Weekly	4	6/19/2018	0.0	0.1	20.8	79.1	30	0.01
GMP-12	Weekly	4	6/27/2018	0.0	0.3	20.1	79.6	30	0.02

TABLE 6

GAS MONITORING PROBE WATER LEVEL DATA

MARCH 29, 2018 – JUNE 30, 2018

Point Name	Date	Quadrant	Depth to Water (ft)	Comments
4ASS	4/5/2018	4	4.4	No Comment
4ASS	4/11/2018	4	4.6	No Comment
4ASS	4/17/2018	4	4.5	No Comment
4ASS	4/24/2018	4	4.7	No Comment
4ASS	4/30/2018	4	5.1	No Comment
4ASS	5/8/2018	4	5.0	No Comment
4ASS	5/15/2018	4	5.2	No Comment
4ASS	5/23/2018	4	5.0	No Comment
4ASS	5/30/2018	4	5.2	No Comment
4ASS	6/5/2018	4	5.2	No Comment
4ASS	6/13/2018	4	5.0	No Comment
4ASS	6/19/2018	4	5.4	No Comment
4ASS	6/27/2018	4	4.9	No Comment
4OSS	4/5/2018	4	8.7	No Comment
4OSS	4/11/2018	4	8.7	No Comment
4OSS	4/17/2018	4	8.6	No Comment
4OSS	4/24/2018	4	8.7	No Comment
4OSS	4/30/2018	4	8.9	No Comment
4OSS	5/8/2018	4	9.1	No Comment
4OSS	5/15/2018	4	9.0	No Comment
4OSS	5/23/2018	4	9.0	No Comment
4OSS	5/30/2018	4	8.9	No Comment
4OSS	6/5/2018	4	9.0	No Comment
4OSS	6/13/2018	4	8.9	No Comment
4OSS	6/19/2018	4	9.3	No Comment
4OSS	6/27/2018	4	9.1	No Comment
GMP-01	4/5/2018	4	11.8	No Comment
GMP-01	4/11/2018	4	11.8	No Comment
GMP-01	4/17/2018	4	11.8	No Comment
GMP-01	4/24/2018	4	11.8	No Comment
GMP-01	4/30/2018	4	11.8	No Comment

Table 6

Point Name	Date	Quadrant	Depth to Water (ft)	Comments
GMP-01	5/8/2018	4	11.8	No Comment
GMP-01	5/15/2018	4	11.8	No Comment
GMP-01	5/23/2018	4	11.8	No Comment
GMP-01	5/30/2018	4	11.8	No Comment
GMP-01	6/5/2018	4	11.8	No Comment
GMP-01	6/13/2018	4	11.9	No Comment
GMP-01	6/19/2018	4	11.8	No Comment
GMP-01	6/27/2018	4	11.8	No Comment
GMP-02	4/5/2018	4	8.6	No Comment
GMP-02	4/11/2018	4	9.5	No Comment
GMP-02	4/17/2018	4	9.4	No Comment
GMP-02	4/24/2018	4	9.5	No Comment
GMP-02	4/30/2018	4	9.4	No Comment
GMP-02	5/8/2018	4	9.4	No Comment
GMP-02	5/15/2018	4	9.4	No Comment
GMP-02	5/23/2018	4	9.4	No Comment
GMP-02	5/30/2018	4	9.4	No Comment
GMP-02	6/5/2018	4	9.4	No Comment
GMP-02	6/13/2018	4	9.5	No Comment
GMP-02	6/19/2018	4	9.4	No Comment
GMP-02	6/27/2018	4	9.4	No Comment
GMP-03	4/5/2018	4	11.8	No Comment
GMP-03	4/11/2018	4	11.8	No Comment
GMP-03	4/17/2018	4	11.5	No Comment
GMP-03	4/24/2018	4	12.0	No Comment
GMP-03	4/30/2018	4	12.3	No Comment
GMP-03	5/8/2018	4	12.5	No Comment
GMP-03	5/15/2018	4	12.8	No Comment
GMP-03	5/23/2018	4	12.9	No Comment
GMP-03	5/30/2018	4	13.0	No Comment
GMP-03	6/5/2018	4	13.6	No Comment

Table 6

Point Name	Date	Quadrant	Depth to Water (ft)	Comments
GMP-03	6/13/2018	4	14.3	No Comment
GMP-03	6/19/2018	4	14.7	No Comment
GMP-03	6/27/2018	4	14.9	No Comment
GMP-05	4/5/2018	3	9.2	No Comment
GMP-06	4/5/2018	1	8.8	No Comment
GMP-07	4/5/2018	1	22.6	No Comment
GMP-08	4/5/2018	1	32.9	No Comment
GMP-08	4/11/2018	1	33.0	No Comment
GMP-08	4/17/2018	1	33.0	No Comment
GMP-08	4/24/2018	1	32.9	No Comment
GMP-08	4/30/2018	1	33.2	No Comment
GMP-08	5/8/2018	1	33.4	No Comment
GMP-08	5/15/2018	1	33.5	No Comment
GMP-08	5/23/2018	1	32.9	No Comment
GMP-08	5/30/2018	1	32.8	No Comment
GMP-08	6/5/2018	1	32.2	No Comment
GMP-08	6/13/2018	1	33.2	No Comment
GMP-08	6/19/2018	1	33.3	No Comment
GMP-08	6/27/2018	1	33.3	No Comment
GMP-09	4/5/2018	4	8.6	No Comment
GMP-09	4/11/2018	4	9.4	No Comment
GMP-09	4/17/2018	4	9.3	No Comment
GMP-09	4/24/2018	4	10.1	No Comment
GMP-09	4/30/2018	4	11.1	No Comment
GMP-09	5/8/2018	4	11.2	No Comment
GMP-09	5/15/2018	4	11.7	No Comment
GMP-09	5/23/2018	4	11.2	No Comment
GMP-09	5/30/2018	4	11.3	No Comment
GMP-09	6/5/2018	4	11.3	No Comment
GMP-09	6/13/2018	4	11.6	No Comment
GMP-09	6/19/2018	4	11.3	No Comment

Table 6

Point Name	Date	Quadrant	Depth to Water (ft)	Comments
GMP-09	6/27/2018	4	11.6	No Comment
GMP-10	4/5/2018	4	7.8	No Comment
GMP-10	4/11/2018	4	9.0	No Comment
GMP-10	4/17/2018	4	8.6	No Comment
GMP-10	4/24/2018	4	9.3	No Comment
GMP-10	4/30/2018	4	9.1	No Comment
GMP-10	5/8/2018	4	10.8	No Comment
GMP-10	5/15/2018	4	9.7	No Comment
GMP-10	5/23/2018	4	9.0	No Comment
GMP-10	5/30/2018	4	9.4	No Comment
GMP-10	6/5/2018	4	9.4	No Comment
GMP-10	6/13/2018	4	9.3	No Comment
GMP-10	6/19/2018	4	10.0	No Comment
GMP-10	6/27/2018	4	9.0	No Comment
GMP-11	4/5/2018	4	0.2	No Comment
GMP-11	4/11/2018	4	0.3	No Comment
GMP-11	4/17/2018	4	0.1	No Comment
GMP-11	4/24/2018	4	0.3	No Comment
GMP-11	4/30/2018	4	0.5	No Comment
GMP-11	5/8/2018	4	0.4	No Comment
GMP-11	5/15/2018	4	0.5	No Comment
GMP-11	5/23/2018	4	0.5	No Comment
GMP-11	5/30/2018	4	0.5	No Comment
GMP-11	6/5/2018	4	0.6	No Comment
GMP-11	6/13/2018	4	0.4	No Comment
GMP-11	6/19/2018	4	1.0	No Comment
GMP-11	6/27/2018	4	0.9	No Comment
GMP-12	4/5/2018	4	0.2	No Comment
GMP-12	4/11/2018	4	0.0	No Comment
GMP-12	4/17/2018	4	0.0	No Comment
GMP-12	4/24/2018	4	0.0	No Comment

Table 6

Point Name	Date	Quadrant	Depth to Water (ft)	Comments
GMP-12	4/30/2018	4	0.4	No Comment
GMP-12	5/8/2018	4	0.0	No Comment
GMP-12	5/15/2018	4	0.4	No Comment
GMP-12	5/23/2018	4	0.2	No Comment
GMP-12	5/30/2018	4	0.4	No Comment
GMP-12	6/5/2018	4	0.2	No Comment
GMP-12	6/13/2018	4	0.4	No Comment
GMP-12	6/19/2018	4	1.0	No Comment
GMP-12	6/27/2018	4	1.1	No Comment
GMP-13D	4/5/2018	4	14.3	No Comment
GMP-13D	4/11/2018	4	13.8	No Comment
GMP-13D	4/17/2018	4	13.3	No Comment
GMP-13D	4/24/2018	4	12.8	No Comment
GMP-13D	4/30/2018	4	12.4	No Comment
GMP-13D	5/8/2018	4	12.0	No Comment
GMP-13D	5/15/2018	4	11.8	No Comment
GMP-13D	5/23/2018	4	11.6	No Comment
GMP-13D	5/30/2018	4	11.5	No Comment
GMP-13D	6/5/2018	4	11.5	No Comment
GMP-13D	6/13/2018	4	11.5	No Comment
GMP-13D	6/19/2018	4	11.6	No Comment
GMP-13D	6/27/2018	4	11.8	No Comment
GMP-13S	4/5/2018	4	7.7	No Comment
GMP-13S	4/11/2018	4	8.5	No Comment
GMP-13S	4/17/2018	4	8.0	No Comment
GMP-13S	4/24/2018	4	8.8	No Comment
GMP-13S	4/30/2018	4	9.3	No Comment
GMP-13S	5/8/2018	4	9.8	No Comment
GMP-13S	5/15/2018	4	10.2	No Comment
GMP-13S	5/23/2018	4	10.6	No Comment
GMP-13S	5/30/2018	4	10.9	No Comment

Point Name	Date	Quadrant	Depth to Water (ft)	Comments
GMP-13S	6/5/2018	4	11.5	No Comment
GMP-13S	6/13/2018	4	12.1	No Comment
GMP-13S	6/19/2018	4	12.4	No Comment
GMP-13S	6/27/2018	4	12.8	No Comment
GMP-14D	4/5/2018	3	5.0	No Comment
GMP-14D	4/11/2018	3	6.1	No Comment
GMP-14D	4/17/2018	3	5.2	No Comment
GMP-14D	4/24/2018	3	6.2	No Comment
GMP-14D	4/30/2018	3	6.8	No Comment
GMP-14D	5/8/2018	3	7.1	No Comment
GMP-14D	5/15/2018	3	7.6	No Comment
GMP-14D	5/23/2018	3	7.5	No Comment
GMP-14D	5/30/2018	3	8.1	No Comment
GMP-14D	6/5/2018	3	8.7	No Comment
GMP-14D	6/13/2018	3	9.3	No Comment
GMP-14D	6/19/2018	3	9.5	No Comment
GMP-14D	6/27/2018	3	9.8	No Comment
GMP-14S	4/5/2018	3	8.0	No Comment
GMP-14S	4/11/2018	3	8.3	No Comment
GMP-14S	4/17/2018	3	7.7	No Comment
GMP-14S	4/24/2018	3	8.3	No Comment
GMP-14S	4/30/2018	3	9.0	No Comment
GMP-14S	5/8/2018	3	9.6	No Comment
GMP-14S	5/15/2018	3	10.1	No Comment
GMP-14S	5/23/2018	3	10.4	No Comment
GMP-14S	5/30/2018	3	10.7	No Comment
GMP-14S	6/5/2018	3	11.5	No Comment
GMP-14S	6/13/2018	3	12.3	No Comment
GMP-14S	6/19/2018	3	12.7	No Comment
GMP-14S	6/27/2018	3	13.1	No Comment
GMP-15D	4/5/2018	2	11.0	No Comment

Point Name	Date	Quadrant	Depth to Water (ft)	Comments
GMP-15D	4/11/2018	2	11.0	No Comment
GMP-15D	4/17/2018	2	10.7	No Comment
GMP-15D	4/24/2018	2	11.1	No Comment
GMP-15D	4/30/2018	2	11.9	No Comment
GMP-15D	5/8/2018	2	11.7	No Comment
GMP-15D	5/15/2018	2	11.7	No Comment
GMP-15D	5/23/2018	2	11.2	No Comment
GMP-15D	5/30/2018	2	11.5	No Comment
GMP-15D	6/5/2018	2	11.4	No Comment
GMP-15D	6/13/2018	2	12.0	No Comment
GMP-15D	6/19/2018	2	11.7	No Comment
GMP-15D	6/27/2018	2	11.6	No Comment
GMP-15S	4/5/2018	2	6.4	No Comment
GMP-15S	4/11/2018	2	6.9	No Comment
GMP-15S	4/17/2018	2	9.3	No Comment
GMP-15S	4/24/2018	2	9.3	No Comment
GMP-15S	4/30/2018	2	9.3	No Comment
GMP-15S	5/8/2018	2	9.4	No Comment
GMP-15S	5/15/2018	2	7.7	No Comment
GMP-15S	5/23/2018	2	7.3	No Comment
GMP-15S	5/30/2018	2	7.5	No Comment
GMP-15S	6/5/2018	2	7.6	No Comment
GMP-15S	6/13/2018	2	7.7	No Comment
GMP-15S	6/19/2018	2	7.9	No Comment
GMP-15S	6/27/2018	2	7.5	No Comment
GMP-16D	4/5/2018	1	6.0	No Comment
GMP-16D	4/11/2018	1	6.4	No Comment
GMP-16D	4/17/2018	1	6.3	No Comment
GMP-16D	4/24/2018	1	6.9	No Comment
GMP-16D	4/30/2018	1	7.2	No Comment
GMP-16D	5/8/2018	1	7.3	No Comment

Point Name	Date	Quadrant	Depth to Water (ft)	Comments
GMP-16D	5/15/2018	1	7.5	No Comment
GMP-16D	5/23/2018	1	7.0	No Comment
GMP-16D	5/30/2018	1	7.0	No Comment
GMP-16D	6/5/2018	1	7.2	No Comment
GMP-16D	6/13/2018	1	7.5	No Comment
GMP-16D	6/19/2018	1	7.6	No Comment
GMP-16D	6/27/2018	1	7.0	No Comment
GMP-16S	4/5/2018	1	6.4	No Comment
GMP-16S	4/11/2018	1	6.7	No Comment
GMP-16S	4/17/2018	1	6.6	No Comment
GMP-16S	4/24/2018	1	7.2	No Comment
GMP-16S	4/30/2018	1	7.5	No Comment
GMP-16S	5/8/2018	1	7.6	No Comment
GMP-16S	5/15/2018	1	7.8	No Comment
GMP-16S	5/23/2018	1	7.3	No Comment
GMP-16S	5/30/2018	1	7.3	No Comment
GMP-16S	6/5/2018	1	7.4	No Comment
GMP-16S	6/13/2018	1	7.8	No Comment
GMP-16S	6/19/2018	1	7.8	No Comment
GMP-16S	6/27/2018	1	7.4	No Comment
GMP-4D	4/5/2018	3	7.0	No Comment
GMP-4D	4/11/2018	3	7.2	No Comment
GMP-4D	4/17/2018	3	6.7	No Comment
GMP-4D	4/24/2018	3	7.1	No Comment
GMP-4D	4/30/2018	3	7.8	No Comment
GMP-4D	5/8/2018	3	8.4	No Comment
GMP-4D	5/15/2018	3	8.9	No Comment
GMP-4D	5/23/2018	3	9.5	No Comment
GMP-4D	5/30/2018	3	9.8	No Comment
GMP-4D	6/5/2018	3	10.5	No Comment
GMP-4D	6/13/2018	3	11.2	No Comment

Table 6

Point Name	Date	Quadrant	Depth to Water (ft)	Comments
GMP-4D	6/19/2018	3	11.6	No Comment
GMP-4D	6/27/2018	3	12.1	No Comment
GMP-4S	4/5/2018	3	6.3	No Comment
GMP-4S	4/11/2018	3	6.5	No Comment
GMP-4S	4/17/2018	3	6.1	No Comment
GMP-4S	4/24/2018	3	6.6	No Comment
GMP-4S	4/30/2018	3	7.3	No Comment
GMP-4S	5/8/2018	3	7.8	No Comment
GMP-4S	5/15/2018	3	8.5	No Comment
GMP-4S	5/23/2018	3	8.9	No Comment
GMP-4S	5/30/2018	3	9.4	No Comment
GMP-4S	6/5/2018	3	10.0	No Comment
GMP-4S	6/13/2018	3	10.9	No Comment
GMP-4S	6/19/2018	3	11.2	No Comment
GMP-4S	6/27/2018	3	11.8	No Comment
GMP-5D	4/5/2018	3	18.4	No Comment
GMP-5D	4/11/2018	3	8.5	No Comment
GMP-5D	4/17/2018	3	18.4	No Comment
GMP-5D	4/24/2018	3	18.7	No Comment
GMP-5D	4/30/2018	3	19.4	No Comment
GMP-5D	5/8/2018	3	19.2	No Comment
GMP-5D	5/15/2018	3	19.6	No Comment
GMP-5D	5/23/2018	3	19.1	No Comment
GMP-5D	5/30/2018	3	19.1	No Comment
GMP-5D	6/5/2018	3	19.4	No Comment
GMP-5D	6/13/2018	3	19.7	No Comment
GMP-5D	6/19/2018	3	19.8	No Comment
GMP-5D	6/27/2018	3	19.6	No Comment
GMP-5S	4/5/2018	3	12.3	No Comment
GMP-5S	4/11/2018	3	12.9	No Comment
GMP-5S	4/17/2018	3	12.6	No Comment

Point Name	Date	Quadrant	Depth to Water (ft)	Comments
GMP-5S	4/24/2018	3	13.1	No Comment
GMP-5S	4/30/2018	3	13.5	No Comment
GMP-5S	5/8/2018	3	13.7	No Comment
GMP-5S	5/15/2018	3	14.0	No Comment
GMP-5S	5/23/2018	3	13.7	No Comment
GMP-5S	5/30/2018	3	14.0	No Comment
GMP-5S	6/5/2018	3	14.3	No Comment
GMP-5S	6/13/2018	3	14.6	No Comment
GMP-5S	6/19/2018	3	14.9	No Comment
GMP-5S	6/27/2018	3	14.7	No Comment
GMP-6D	4/5/2018	3	9.9	No Comment
GMP-6D	4/11/2018	3	10.0	No Comment
GMP-6D	4/17/2018	3	9.9	No Comment
GMP-6D	4/24/2018	3	10.3	No Comment
GMP-6D	4/30/2018	3	10.7	No Comment
GMP-6D	5/8/2018	3	10.8	No Comment
GMP-6D	5/15/2018	3	11.0	No Comment
GMP-6D	5/23/2018	3	10.7	No Comment
GMP-6D	5/30/2018	3	10.7	No Comment
GMP-6D	6/5/2018	3	11.0	No Comment
GMP-6D	6/13/2018	3	10.4	No Comment
GMP-6D	6/19/2018	3	11.5	No Comment
GMP-6D	6/27/2018	3	11.4	No Comment
GMP-6S	4/5/2018	3	6.0	No Comment
GMP-6S	4/11/2018	3	6.3	No Comment
GMP-6S	4/17/2018	3	6.0	No Comment
GMP-6S	4/24/2018	3	6.7	No Comment
GMP-6S	4/30/2018	3	7.4	No Comment
GMP-6S	5/8/2018	3	7.4	No Comment
GMP-6S	5/15/2018	3	7.8	No Comment
GMP-6S	5/23/2018	3	7.1	No Comment

Point Name	Date	Quadrant	Depth to Water (ft)	Comments
GMP-6S	5/30/2018	3	7.3	No Comment
GMP-6S	6/5/2018	3	7.8	No Comment
GMP-6S	6/13/2018	3	8.2	No Comment
GMP-6S	6/19/2018	3	8.5	No Comment
GMP-6S	6/27/2018	3	8.3	No Comment
GMP-7D	4/5/2018	1	16.7	No Comment
GMP-7D	4/11/2018	1	17.4	No Comment
GMP-7D	4/17/2018	1	17.1	No Comment
GMP-7D	4/24/2018	1	17.8	No Comment
GMP-7D	4/30/2018	1	18.0	No Comment
GMP-7D	5/8/2018	1	18.0	No Comment
GMP-7D	5/15/2018	1	18.3	No Comment
GMP-7D	5/23/2018	1	17.4	No Comment
GMP-7D	5/30/2018	1	17.7	No Comment
GMP-7D	6/5/2018	1	17.7	No Comment
GMP-7D	6/13/2018	1	18.1	No Comment
GMP-7D	6/19/2018	1	18.3	No Comment
GMP-7D	6/27/2018	1	17.0	No Comment
GMP-7S	4/5/2018	1	15.2	No Comment
GMP-7S	4/11/2018	1	16.5	No Comment
GMP-7S	4/17/2018	1	17.9	No Comment
GMP-7S	4/24/2018	1	17.0	No Comment
GMP-7S	4/30/2018	1	17.3	No Comment
GMP-7S	5/8/2018	1	17.2	No Comment
GMP-7S	5/15/2018	1	17.6	No Comment
GMP-7S	5/23/2018	1	18.1	No Comment
GMP-7S	5/30/2018	1	16.9	No Comment
GMP-7S	6/5/2018	1	16.8	No Comment
GMP-7S	6/13/2018	1	17.3	No Comment
GMP-7S	6/19/2018	1	17.6	No Comment
GMP-7S	6/27/2018	1	15.1	No Comment

Table 6

Point Name	Date	Quadrant	Depth to Water (ft)	Comments
TMP-1D	4/5/2018	4	21.2	No Comment
TMP-1D	4/11/2018	4	21.3	No Comment
TMP-1D	4/17/2018	4	21.2	No Comment
TMP-1D	4/24/2018	4	21.5	No Comment
TMP-1D	4/30/2018	4	22.1	No Comment
TMP-1D	5/8/2018	4	21.9	No Comment
TMP-1D	5/15/2018	4	22.1	No Comment
TMP-1D	5/23/2018	4	21.8	No Comment
TMP-1D	5/30/2018	4	21.5	No Comment
TMP-1D	6/5/2018	4	21.4	No Comment
TMP-1D	6/13/2018	4	21.9	No Comment
TMP-1D	6/19/2018	4	21.7	No Comment
TMP-1D	6/27/2018	4	21.8	No Comment
TMP-1M	4/5/2018	4	21.3	No Comment
TMP-1M	4/11/2018	4	21.7	No Comment
TMP-1M	4/17/2018	4	21.6	No Comment
TMP-1M	4/24/2018	4	22.0	No Comment
TMP-1M	4/30/2018	4	22.2	No Comment
TMP-1M	5/8/2018	4	22.6	No Comment
TMP-1M	5/15/2018	4	22.7	No Comment
TMP-1M	5/23/2018	4	22.4	No Comment
TMP-1M	5/30/2018	4	22.2	No Comment
TMP-1M	6/5/2018	4	22.4	No Comment
TMP-1M	6/13/2018	4	22.2	No Comment
TMP-1M	6/19/2018	4	22.4	No Comment
TMP-1M	6/27/2018	4	22.4	No Comment
TMP-1S	4/5/2018	4	19.1	No Comment
TMP-1S	4/11/2018	4	19.7	No Comment
TMP-1S	4/17/2018	4	19.6	No Comment
TMP-1S	4/24/2018	4	20.3	No Comment
TMP-1S	4/30/2018	4	20.9	No Comment

Point Name	Date	Quadrant	Depth to Water (ft)	Comments
TMP-1S	5/8/2018	4	21.0	No Comment
TMP-1S	5/15/2018	4	21.3	No Comment
TMP-1S	5/23/2018	4	20.6	No Comment
TMP-1S	5/30/2018	4	20.6	No Comment
TMP-1S	6/5/2018	4	20.9	No Comment
TMP-1S	6/13/2018	4	21.0	No Comment
TMP-1S	6/19/2018	4	21.0	No Comment
TMP-1S	6/27/2018	4	20.8	No Comment
TMP-2D	4/5/2018	4	17.1	No Comment
TMP-2D	4/11/2018	4	18.2	No Comment
TMP-2D	4/17/2018	4	18.2	No Comment
TMP-2D	4/24/2018	4	20.0	No Comment
TMP-2D	4/30/2018	4	22.0	No Comment
TMP-2D	5/8/2018	4	20.6	No Comment
TMP-2D	5/15/2018	4	20.7	No Comment
TMP-2D	5/23/2018	4	20.0	No Comment
TMP-2D	5/30/2018	4	20.5	No Comment
TMP-2D	6/5/2018	4	20.7	No Comment
TMP-2D	6/13/2018	4	20.9	No Comment
TMP-2D	6/19/2018	4	21.0	No Comment
TMP-2D	6/27/2018	4	20.8	No Comment
TMP-2M	4/5/2018	4	17.1	No Comment
TMP-2M	4/11/2018	4	18.3	No Comment
TMP-2M	4/17/2018	4	18.2	No Comment
TMP-2M	4/24/2018	4	19.8	No Comment
TMP-2M	4/30/2018	4	20.5	No Comment
TMP-2M	5/8/2018	4	20.3	No Comment
TMP-2M	5/15/2018	4	20.3	No Comment
TMP-2M	5/23/2018	4	19.8	No Comment
TMP-2M	5/30/2018	4	20.2	No Comment
TMP-2M	6/5/2018	4	19.8	No Comment

Point Name	Date	Quadrant	Depth to Water (ft)	Comments
TMP-2M	6/13/2018	4	15.5	No Comment
TMP-2M	6/19/2018	4	19.8	No Comment
TMP-2M	6/27/2018	4	20.1	No Comment
TMP-2S	4/5/2018	4	16.2	No Comment
TMP-2S	4/11/2018	4	17.2	No Comment
TMP-2S	4/17/2018	4	17.3	No Comment
TMP-2S	4/24/2018	4	17.1	No Comment
TMP-2S	4/30/2018	4	17.5	No Comment
TMP-2S	5/8/2018	4	17.3	No Comment
TMP-2S	5/15/2018	4	17.3	No Comment
TMP-2S	5/23/2018	4	17.2	No Comment
TMP-2S	5/30/2018	4	17.4	No Comment
TMP-2S	6/5/2018	4	17.3	No Comment
TMP-2S	6/13/2018	4	17.5	No Comment
TMP-2S	6/19/2018	4	17.4	No Comment
TMP-2S	6/27/2018	4	17.4	No Comment
TMP-3D	4/5/2018	4	17.3	No Comment
TMP-3D	4/11/2018	4	17.6	No Comment
TMP-3D	4/17/2018	4	17.7	No Comment
TMP-3D	4/24/2018	4	17.7	No Comment
TMP-3D	4/30/2018	4	18.4	No Comment
TMP-3D	5/8/2018	4	17.9	No Comment
TMP-3D	5/15/2018	4	18.0	No Comment
TMP-3D	5/23/2018	4	18.0	No Comment
TMP-3D	5/30/2018	4	17.6	No Comment
TMP-3D	6/5/2018	4	16.6	No Comment
TMP-3D	6/13/2018	4	17.3	No Comment
TMP-3D	6/19/2018	4	16.8	No Comment
TMP-3D	6/27/2018	4	18.1	No Comment
TMP-3M	4/5/2018	4	18.0	No Comment
TMP-3M	4/11/2018	4	18.1	No Comment

Point Name	Date	Quadrant	Depth to Water (ft)	Comments
TMP-3M	4/17/2018	4	18.0	No Comment
TMP-3M	4/24/2018	4	18.6	No Comment
TMP-3M	4/30/2018	4	19.4	No Comment
TMP-3M	5/8/2018	4	19.1	No Comment
TMP-3M	5/15/2018	4	19.0	No Comment
TMP-3M	5/23/2018	4	18.1	No Comment
TMP-3M	5/30/2018	4	18.0	No Comment
TMP-3M	6/5/2018	4	18.2	No Comment
TMP-3M	6/13/2018	4	19.1	No Comment
TMP-3M	6/19/2018	4	17.6	No Comment
TMP-3M	6/27/2018	4	19.2	No Comment
TMP-3S	4/5/2018	4	17.5	No Comment
TMP-3S	4/11/2018	4	18.1	No Comment
TMP-3S	4/17/2018	4	18.0	No Comment
TMP-3S	4/24/2018	4	18.6	No Comment
TMP-3S	4/30/2018	4	19.7	No Comment
TMP-3S	5/8/2018	4	19.6	No Comment
TMP-3S	5/15/2018	4	20.2	No Comment
TMP-3S	5/23/2018	4	19.5	No Comment
TMP-3S	5/30/2018	4	19.7	No Comment
TMP-3S	6/5/2018	4	20.0	No Comment
TMP-3S	6/13/2018	4	20.0	No Comment
TMP-3S	6/19/2018	4	19.9	No Comment
TMP-3S	6/27/2018	4	20.1	No Comment

APPENDIX A

LANDFILL GAS CORRECTIVE ACTION PLAN UPDATE, JULY 26, 2013

**BRIDGETON LANDFILL
LANDFILL GAS CORRECTIVE ACTION PLAN UPDATE**

**Submitted Pursuant to Section 23 of Agreed Order
Case No. 13SL-CC01088, Effective May 13, 2013**

**Bridgeton Landfill, LLC
13570 St. Charles Rock Rd.
Bridgeton, MO 63044**

Technical Contributors:

Civil & Environmental Consultants, Inc.
4848 Park 370, Suite F
Hazelwood, MO 63042

Weaver Boos Consultants
1000 N. College Ave., Suite D
Columbia, MO 65201

July 26, 2013

TABLE OF CONTENTS

1.0	INTRODUCTION.....	1
2.0	REVIEW OF CURRENT GAS MIGRATION CONTROL STATUS	2
3.0	RECENT GAS MIGRATION CONTROL EFFORTS	5
4.0	PROPOSED AND ONGOING GAS MIGRATION CONTROL EFFORTS	7
5.0	CONTINUED MONITORING AND REPORTING.....	9

TABLES

- Table 1: Compliance Gas Monitoring Probe Data (11/21/12 – 7/5/13)
- Table 2: Sentry Gas Monitoring Probe Data (11/21/12 – 7/5/13)
- Table 3: Temporary Gas Monitoring Probe Data (11/21/12 – 7/5/13)
- Table 4: Public Safety Gas Monitoring Probe Data (11/21/12 – 7/5/13)

APPENDICES

- Appendix A – Gas Monitoring Probe Methane Level Graphs
- Appendix B – GMP and TMP Boring Logs/Construction Logs
- Appendix C – Bridgeton Landfill Infrastructure As-Built Drawing, July 2013

1.0 INTRODUCTION

On May 13, 2013, Bridgeton Landfill entered into an Agreed Order with the State of Missouri which requires actions to address what was called a subsurface smoldering event (SSE). Section 23 of the Agreed Order requires the preparation of an updated "Landfill Gas Corrective Action Plan" (CAP) and requests that the update consider SSE control measures.

Missouri Solid Waste Management Regulations require that subsurface landfill gas be controlled so that it does not exceed 2.5% (which is equal to 50% of the lower explosive limit, or LEL) in the ground at the facility property boundary. If this level is exceeded at the property boundary, the facility must implement enhanced monitoring and corrective measures. Corrective Action Plans are frequently used to present and communicate these measures.

Bridgeton Landfill has been monitoring for gas migration using permanent gas monitoring probes since 1998. Since that time, landfill gas Corrective Action Plans have been implemented, additional monitoring locations have been added, and many control features have been installed. These efforts have been previously documented and are incorporated by reference as background for this current work.

Lateral landfill gas migration is common at unlined municipal solid waste (MSW) landfills, and especially in quarry fill environments. Bridgeton Landfill has some areas where the property line is close to solid waste limits (near the edge of the quarry wall) and monitoring has detected methane near the property line in certain locations. In addition, the SSE that Bridgeton Landfill has been experiencing since 2010, and that intensified in 2012, has further challenged methane control in those areas.

The purpose of this document, as required by the Agreed Order, is to provide an update to the November 27, 2012 CAP that considers the SSE control measures. As such, this document includes monitoring data up to July 2013, reviews the status of gas migration control, presents recent (since the approved November 27, 2012 CAP) efforts to reduce methane migration, and discusses forward-going monitoring and reporting procedures. It is intended that this CAP supplements and/or supersedes the previous CAPs and agreements.

2.0 REVIEW OF CURRENT GAS MIGRATION CONTROL STATUS

The intensification of the SSE has created conditions that have made control of gas migration more challenging, including:

- Increased pressure within the landfill waste with pressure-gradient which forces gas outward;
- Increased liquid generation resulting in steam and saturated gas which effects collection efficiency, and
- Carefully controlled and reduced application of gas extraction well vacuum with efforts to minimize oxygen content in the gas well.

Detailed graphs showing methane concentrations for the past three years are included in Appendix A. Appendix B includes a list of the gas monitoring probes monitored at the Bridgeton Landfill along with the boring logs and/or construction logs for each probe. Please note, the gas monitoring probes has been referenced with different abbreviations and the table in Appendix B is included to provide clarity.

As can be seen on the graphs, there are several compliance point and sentry monitoring probe locations that have been historically elevated (GMP-01, GMP-04, GMP-05 GMP-06 and GMP-07), as well as elevated levels in new gas monitoring probes where monitoring began in October 2012 after the SSE intensified (GMP-5S, GMP-14S, GMP-14D). Temporary monitoring probes installed to determine the rate and extent of the methane migration in the vicinity of impacted probe GMP-01 (TMP-1S, TMP-2S, TMP-2M, TMP-2D, TMP-3S, TMP-3M, and TMP-3D) have also exhibited elevated levels of methane since installation.

Due to the additional gas monitoring probes, which initiated monitoring in October 2012 to better define the zone of migration on the eastern boundary of the landfill, GMP-04 through GMP-07 located closer to the landfill are typically monitored on a quarterly basis but are sentry probes and are no longer utilized as the compliance probes in accordance with Missouri Solid Waste Law and Rules. Tables 1 through 4 present the probe results for the monitoring period November 21, 2012 through July 5, 2013.

Along the southern boundary of the landfill, adjacent to Boenker Road, GMP-01 has continued to show elevated levels above the regulatory threshold. Corrective measures have not been effective to address the migration in this vicinity. Corrective actions taken to date have focused on methane migration within the soil overburden due to investigative action demonstrating shallow migration. However, after the installation of the interceptor trench, which was constructed to the soil/bedrock interface between the waste disposal area and impacted GMP-01, elevated levels continued to be exhibited in GMP-01. Due to the ineffectiveness of the perimeter gas wells (2005) and interceptor trench (2010) installed in the vicinity of GMP-01 to eliminate or reduce methane impacts, further investigation was deemed necessary under the conditions of the Settlement Agreement.

In order to effectively determine the zone of migration in the vicinity of GMP-01, temporary probes (TMP-1, TMP-2 and TMP-3) were installed as investigation probes to better define the zone of migration. In order to do this, each temporary probe were installed as nested probes with three monitored zones – shallow (S), middle (M) and deep (D). The shallow zone was screened within the soil overburden; the middle zone was screened through the uppermost weathered/fractured bedrock and the deep zone within the saturated bedrock. As presented in Appendix A, TMP-1 located west of GMP-01 is impacted with elevated methane levels within the soil overburden and weathered bedrock. TMP-2, located east of GMP-01, and TMP-3, located north of GMP-01, has observed elevated methane in each of the monitored zones. It is likely the observed elevated methane within the deep monitored zone observed in TMP-2 and TMP-3 are a result of diffusion transport due to these probes located less than 75 feet from the waste mass as well as the pressure-gradient force caused by the SSE as noted with increased relative pressure during monitoring of the probes.

As noted in the TMP boring logs, weathered bedrock was observed at lower elevations than the base of the interceptor trench. TMP-1, located west of GMP-1, the weathered bedrock was observed between 36 feet below ground surface (bgs) to 66.5 feet bgs. TMP-2, located east of GMP-1, the weathered bedrock was observed between 18 feet bgs to 47 feet bgs. TMP-3, located between the landfill and GMP-1, the weathered bedrock was observed between 31 feet bgs to 50 feet bgs. TMP-2, located between the landfill and GMP-1, the weathered bedrock was observed between 31 feet bgs to 50 feet bgs. Due to weathered bedrock observed at lower elevations than the base of the interceptor trench, it is likely methane continues to migrate through these weathered zones. Table 3 presents the temporary gas monitoring probe data.

The intensification of the SSE in 2012, resulting in increased pressure within the landfill, brought challenges associated within dewatering the interceptor trench located south of the waste boundary and maintaining sufficient vacuum on select gas extraction wells located within the south quarry. As a result, elevated levels of methane continue to be observed since October 2012.

Currently the public safety probes located across Boenker Road, on private property (GMP-09, GMP-10, GMP-11, and GMP-12) have no detectable levels of methane and have not observed elevated methane in two years (GMP-11). There is no evidence of methane migration onto adjacent properties at this time. Table 4 presents the gas monitoring probe data for the public safety probes.

Along the east property boundary, adjacent to the south quarry, elevated methane has been observed at two gas monitoring probe locations utilized for compliance: GMP-5S, GMP-14S, GMP-14D. The gas monitoring probes installed between August and September 2012 were installed as nested probes with two monitoring zones - shallow (S) and deep (D). The shallow zone was screened within the soil overburden; the deep zone was screened through the uppermost weathered bedrock to approximately 10 feet below the historic low water table.

The intent of these nested probes is to determine if methane migration is occurring at the property boundary as well as to ascertain the zone in which it is occurring. Similar to GMP-01, weathered bedrock was observed below the soil overburden at GMP-14 where GMP-14D is screened. The weathered bedrock is likely providing a zone of migration within the deeper zone, GMP-14D.

As described in Section 3.0, Bridgeton Landfill has performed recent improvements that should ultimately reduce landfill gas migration.

3.0 RECENT GAS MIGRATION CONTROL EFFORTS

Many recent additional measures have been recently undertaken that should ultimately reduce gas migration, including:

1. The SSE has impacted the facility's infrastructure designed to remove liquid efficiently from the waste mass which results in increased liquid in the force main and the gas conveyance system resulting in a reduction of their efficiency to remove landfill gas. Adding new gas extraction wells, replacing compromised gas extraction wells, and adding liquid pumps and extraction points will improve landfill gas collection and improve overall efficiency of the system. The following features have been installed per the November 27, 2012 CAP and in addition to the measures proposed in the CAP:
 - In November 2012 the Bridgeton Landfill installed 5 new trench wells, 5 new liquid sumps, and 7 new gas extraction wells.
 - During the January 1, 2013 through June 30, 2013 period the following additional extraction points were installed at the Bridgeton Landfill:
 - In February 2013 the Bridgeton Landfill installed 9 new gas extraction wells,
 - In March 2013 the Bridgeton Landfill installed 3 new gas extraction wells,
 - In April 2013 the Bridgeton Landfill installed 11 new gas extraction wells,
 - In May 2013 the Bridgeton Landfill installed 13 new gas extraction wells,
2. Addition of a 2,500 scfm utility flare in the southeastern portion of the disposal area in June 2013. This flare has improved vacuum distribution around the well field, especially in the southern and southeastern end where migration has been problematic.
3. Installation of 25 perimeter liquid sumps connected by perforated liquid/gas collection piping in May and June 2013. These were installed as part of the South Quarry capping project, and will allow collection of additional gas at the perimeter of the landfill, and
4. Placement of 32 acres of geomembrane cap and enhanced gas collection features which should be completed in August 2013. The cap will allow additional vacuum to be pulled from the cover integrity system consisting of a composite liner system which will reduce concern for oxygen intrusion. This should result in better long term gas capture and, in time, reduced gas pressure.

An updated as-built map that shows all of these features that were in place as of June 30, 2013 is included in Appendix C.

Due to the increased liquid generation and increased pressure within the landfill the improvements completed within the past nine months have not yet resulted in a reduction of methane observed within the gas monitoring probes. It is premature to evaluate the

effectiveness of the recent gas migration control efforts outlined in this section due to impacts associated with increased liquid generation and the continued dynamic movement and changes of the SSE in the South Quarry area.

4.0 PROPOSED AND ONGOING GAS MIGRATION CONTROL EFFORTS

The recent additional measures outlined in Section 3.0 are on-going efforts to improve landfill gas control at the Bridgeton Landfill. These upgrades should reduce pressure within the waste mass that may be contributing to the exceedances and in turn alleviate methane migration along the southern and eastern property boundaries. Improvements to the landfill are on-going and will continue until the SSE is controlled. Below are additional improvements that are being proposed or currently implemented:

1. The SSE has resulted in an increase in condensate generation. In order to improve liquid removal at the site a third party consultant has been contracted to evaluate the effectiveness of the existing force main. Due to the increased liquid movement within the force main pressure has built up within the system resulting in back pressure and reduced pump functionality. Pressure relief valves have been installed on numerous pneumatic pumps to address this issue. However, due to the increased liquid generation additional capacity within the force main is needed. As such, the preliminary design proposes utilizing the existing force main for management of liquid removed from the LCSs and a second separate force main for liquids removed from the remaining extraction points. The additional liquid force main will allow optimum operations of the pumps while providing increased available vacuum on the landfill gas collection system. This corrective action measure will be submitted to the MDNR in third quarter 2013 sealed by a Missouri Professional Engineer.
2. In order to improve liquid management once the liquids are removed from the disposal area the Bridgeton Landfill has contracted with a third party consulting firm for additional storage and pretreatment of the extracted liquid. During the second quarter 2013 the landfill installed a 316,000 gallon above ground liquid storage and treatment tank. The preliminary treatment plant design includes incorporation of the existing 96,000 gallon tank located near Boenker Road, the newly installed 316,000 gallon tank, four-1,000,000 gallon tanks and a pretreatment facility. This will provide the landfill additional capacity to remove the liquid from the disposal area at a design capacity of 300,000 gallons per day. The treatment plant design will be submitted to the MDNR in third quarter 2013 sealed by a Missouri Professional Engineer.
3. The Bridgeton Landfill has submitted a Permit to Construct application to the St. Louis County Department of Health for the installation of two 4,000 scfm utility flares. These utility flares would replace the existing enclosed flares with a design flow of 3,500 scfm each. The replacement of the enclosed flares with the two 4,000 scfm utility flares coupled with the existing 3,500 scfm John Zink utility flare and the 2,500 scfm LFG Specialties utility flare will provide a combined design flow of the four utility flares of 14,000 scfm. Authorization to Construct is anticipated to be issued by the end of July 2013. The installation of the 4,000 scfm utility flares is anticipated to be completed shortly after permit issuance with operations of each unit by the end of third quarter

2013. Utility flares are better suited to handle the lower heating value gas at the Bridgeton Landfill resulting in less downtime of the control devices.

4. A natural gas line has been installed in the vicinity of the flare compound. It will be connected to the gas collection system if the lower heating value or hydrogen concentration drop below levels to effectively operate the landfill gas control devices.
5. The Bridgeton Landfill will be upgrading the landfill gas coolers at the east utility flare (2,500 scfm LFG Specialties) and at the flare compound in the near future. This improvement will result in additional vacuum available to the well field.

The improvements associated with the liquid conveyance system and the landfill gas control devices are essential to address methane migration at the facility. These efforts should result in a decrease in pressure within the landfill and improved landfill gas collection efficiencies within the south quarry. The liquid force main modification and the liquid treatment system will be submitted to the MDNR for review and approval. The landfill appreciates the continued support to address the SSE in a timely manner and appreciates an expedited review of these submittals.

Monitoring results of the nested gas and temporary monitoring probes have shown that methane is migrating through the weathered bedrock and additional controls are likely needed to address these exceedances. However, due to increased liquid generation associated with the SSE, the effectiveness of the recent improvements could not be determined. It is requested to further evaluate the zone of migration of the impacted gas monitoring and temporary monitoring probes with weekly water level readings and monitoring of the impacted probes to better delineate if methane is migrating through deeper zones. It is requested that this evaluation period be extended through the third quarter 2013. At that time a comprehensive corrective action plan will be submitted evaluating the impact of the recently-completed capping, other recent measures, and the proposed measures described above. During this period the landfill will continue to complete improvements to the liquid conveyance system in efforts to minimize liquids within the gas collection system.

5.0 CONTINUED MONITORING AND REPORTING

The Bridgeton Landfill will initiate weekly monitoring of all monitoring probes including the gas monitoring probes, sentry probes and temporary monitoring probes. The Bridgeton Landfill proposes that landfill gas corrective summary reports to be incorporated into the quarterly report and submitted by the 15th of each month following a calendar quarter. These reports will summarize all corrective action completed to address methane migration within the prior quarter and, if elevated levels persist, provide a corrective action plan to address the methane exceedances.

Bridgeton Landfill understands that the submittal of quarterly landfill gas corrective action summary reports and corrective action plans is at a higher frequency than outlined in Paragraph 4 of the January 17, 2011 Settlement Agreement between the MDNR and the Bridgeton Landfill but believes that incorporation in the quarterly report is valuable.

This section of the report will include at a minimum a review previous data, evaluate effectiveness of efforts made to control migration, and propose additional measures directed at eliminating detection levels in gas monitoring probes. As a regular procedure, these reports will be submitted by the 15th of each month following a calendar quarter.

Bridgeton Landfill will continue to take aggressive action to control the impacts of the SSE, evaluate corrective measures to address methane migration within the weathered bedrock and improve gas collection within the limits of waste. Any major new gas migration control features needed--particularly those located outside the limit of waste--would be designed and sealed by a Missouri professional engineer and submitted to the MDNR for comment and approval.

The MDNR will continue to provide ongoing review, comment, and approval of actions as it deems necessary. This reporting process will continue until Bridgeton Landfill demonstrates uninterrupted compliance with the MDNR's methane regulations (all compliance gas monitoring probes less than 2.5% methane) for a period of one year.

APPENDIX B

GAS MONITORING PROBE METHANE LEVEL GRAPHS

Southern and Western Compliance Probes

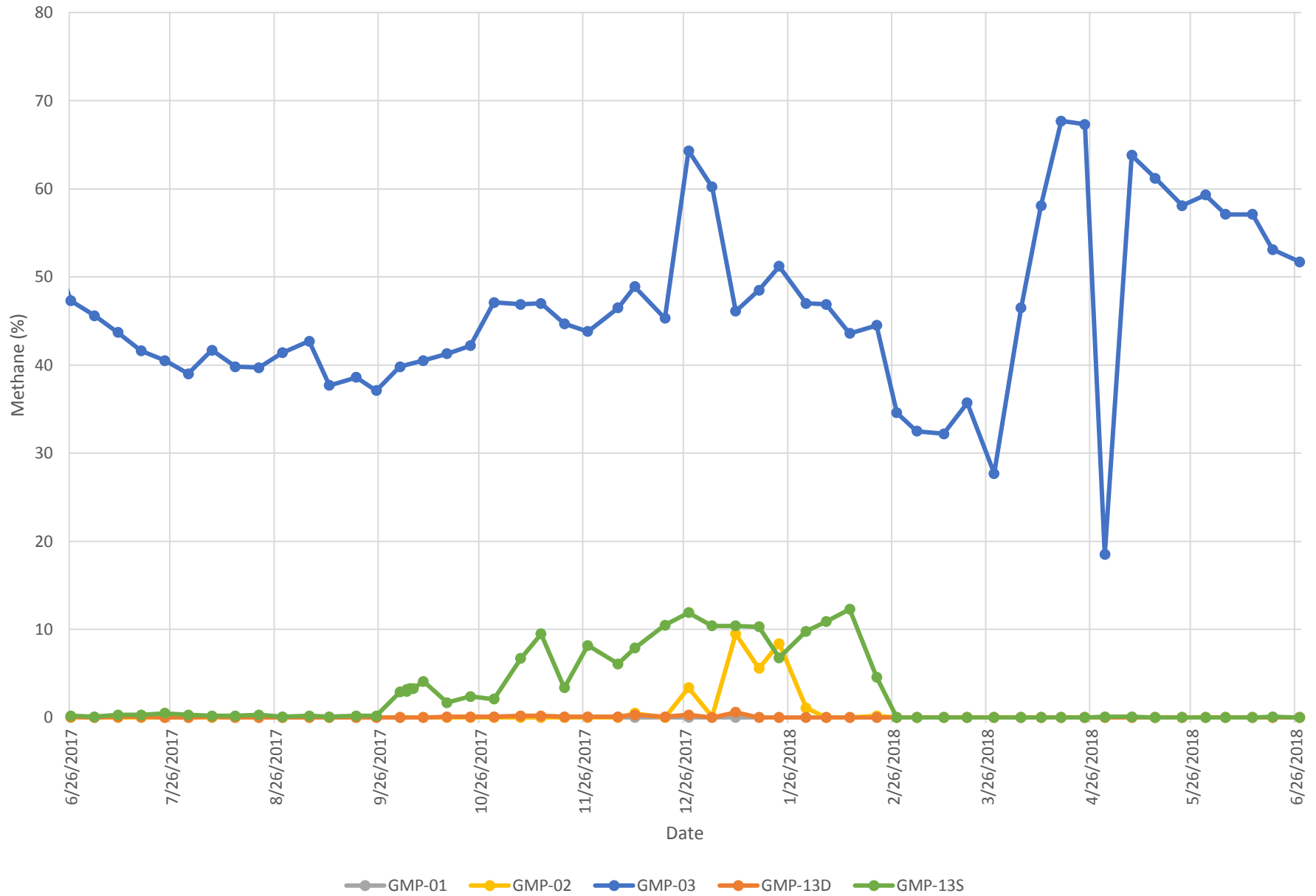

Eastern Compliance Probes

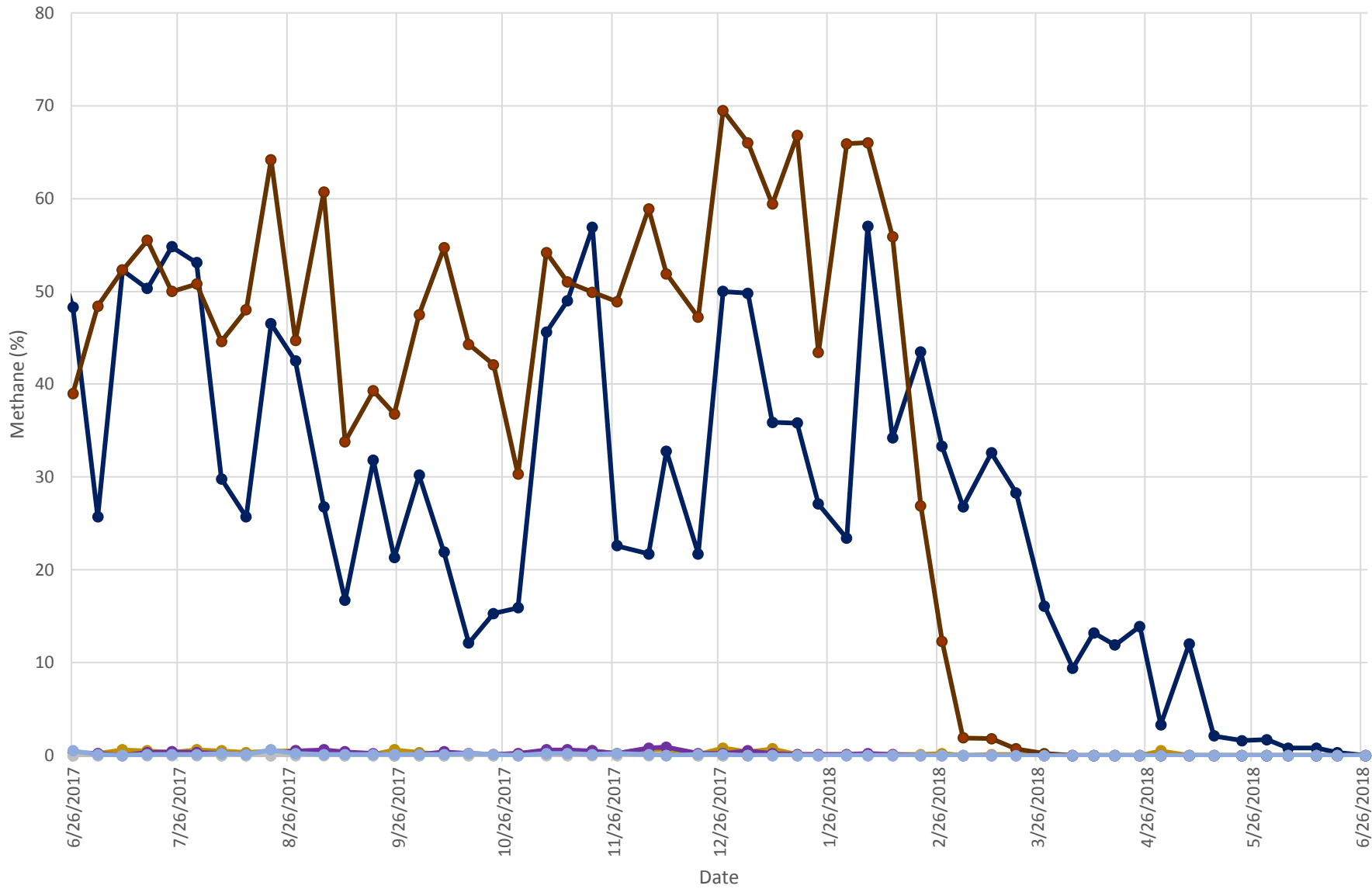

Legend: GMP-4D (yellow), GMP-4S (dark blue), GMP-5D (green), GMP-5S (purple), GMP-6D (orange), GMP-6S (grey), GMP-14D (brown), GMP-14S (light blue)

North Compliance Probes

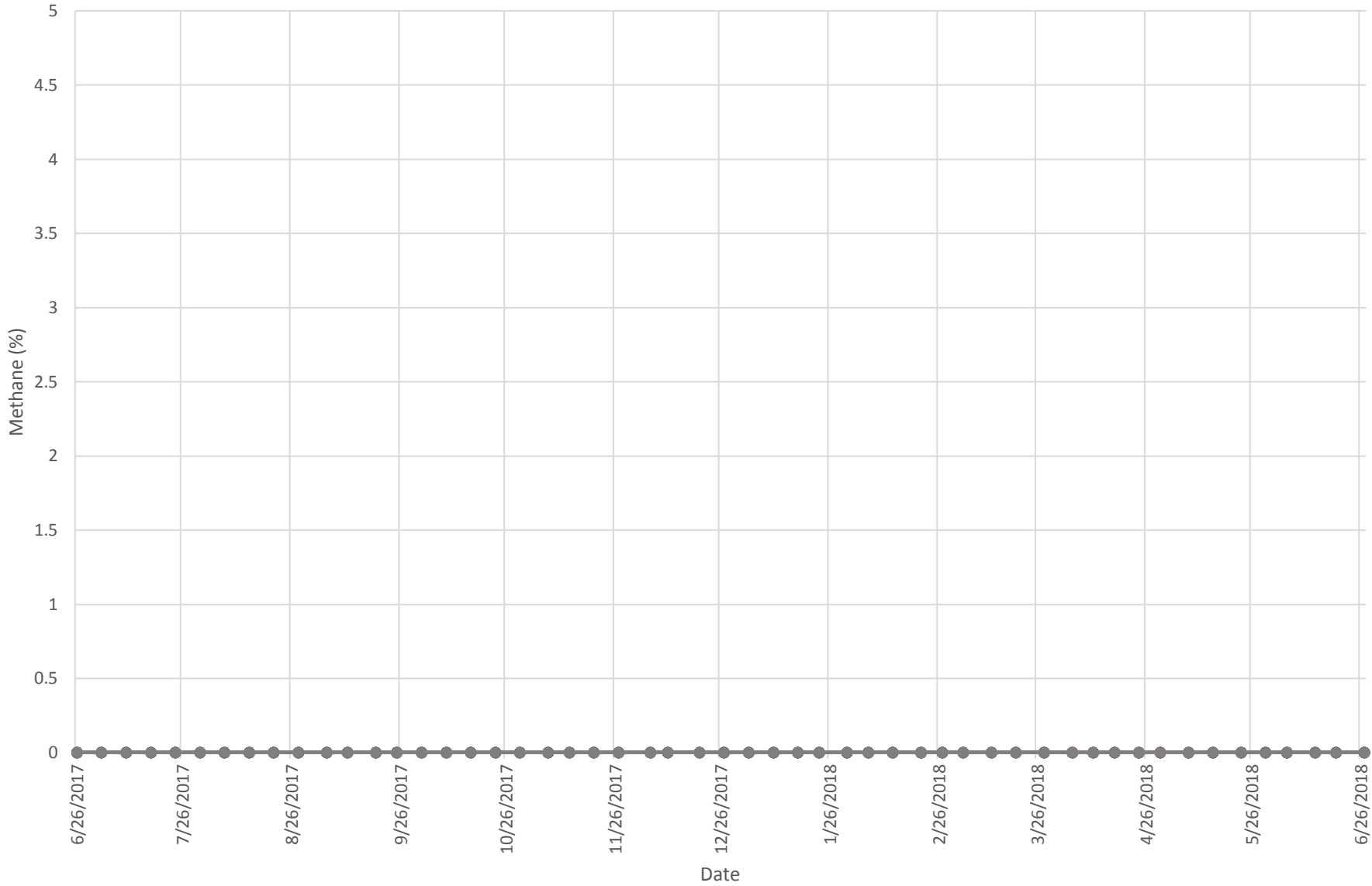

Legend: GMP-7D (Yellow), GMP-7S (Light Blue), GMP-08 (Black), GMP-15D (Green), GMP-15S (Blue), GMP-16D (Red), GMP-16S (Grey)

Sentry Probes

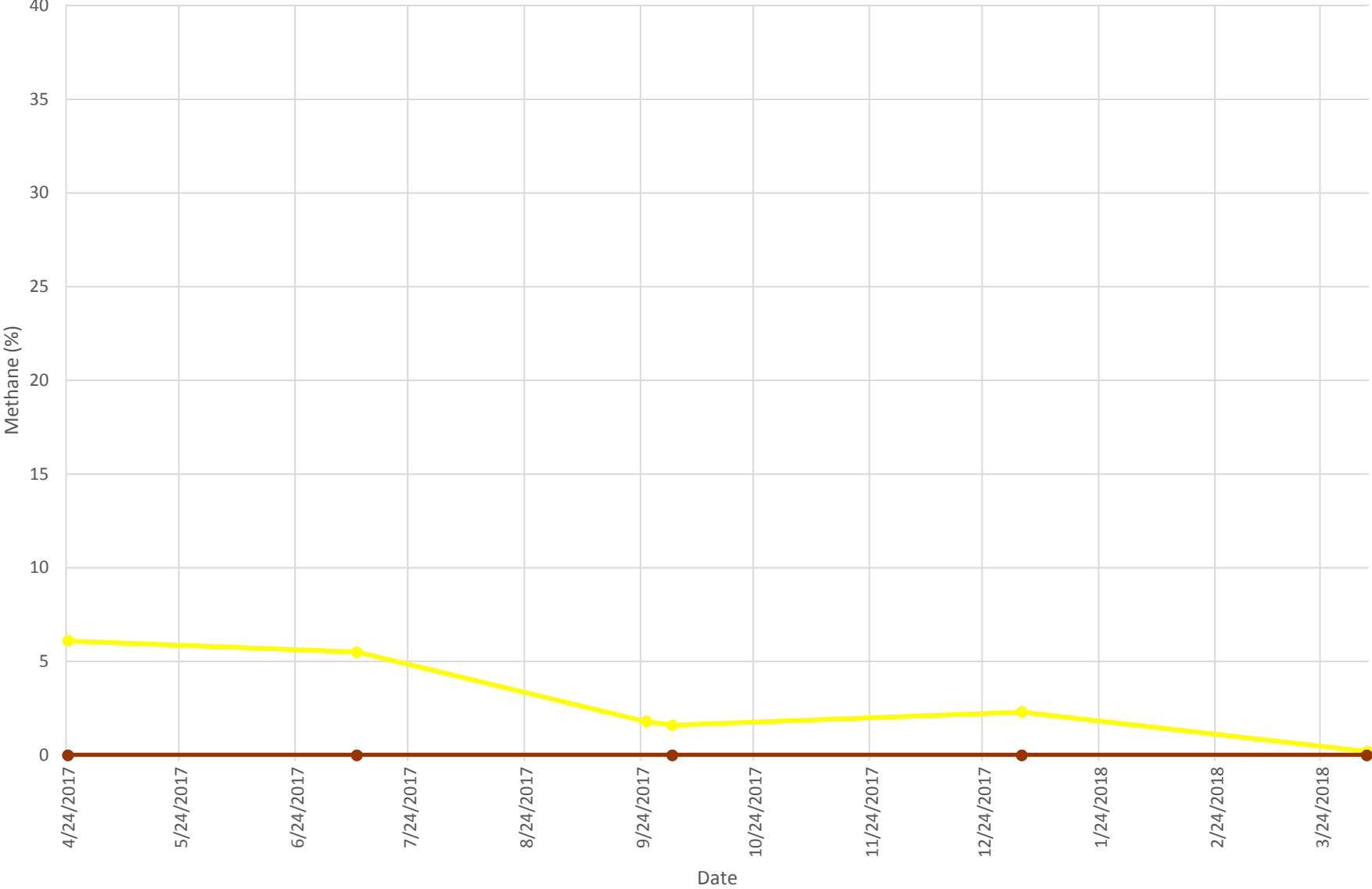

—●— GMP-05 —●— GMP-06 —●— GMP-07

Shallow Investigative Probes

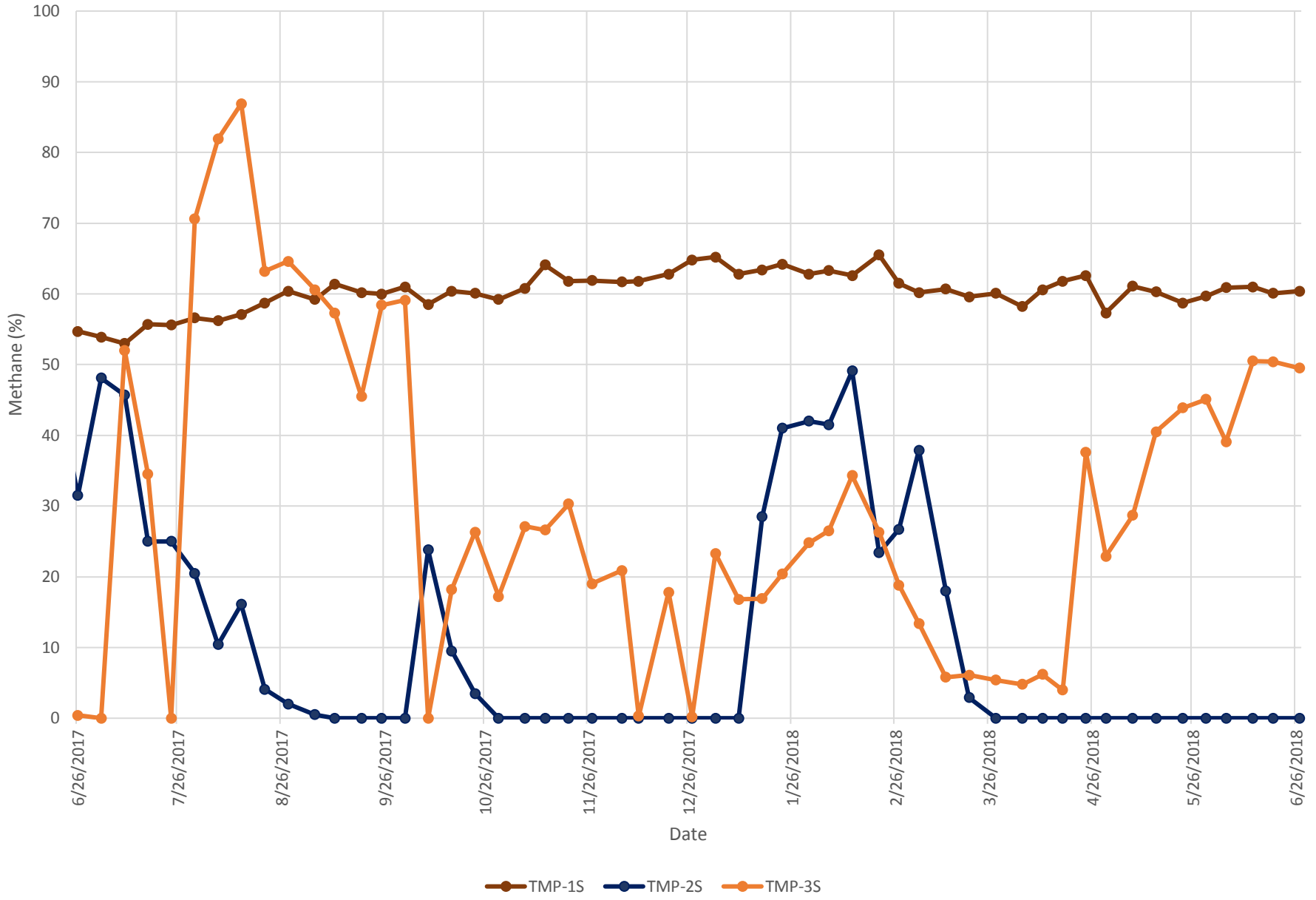

Mid Investigative Probes

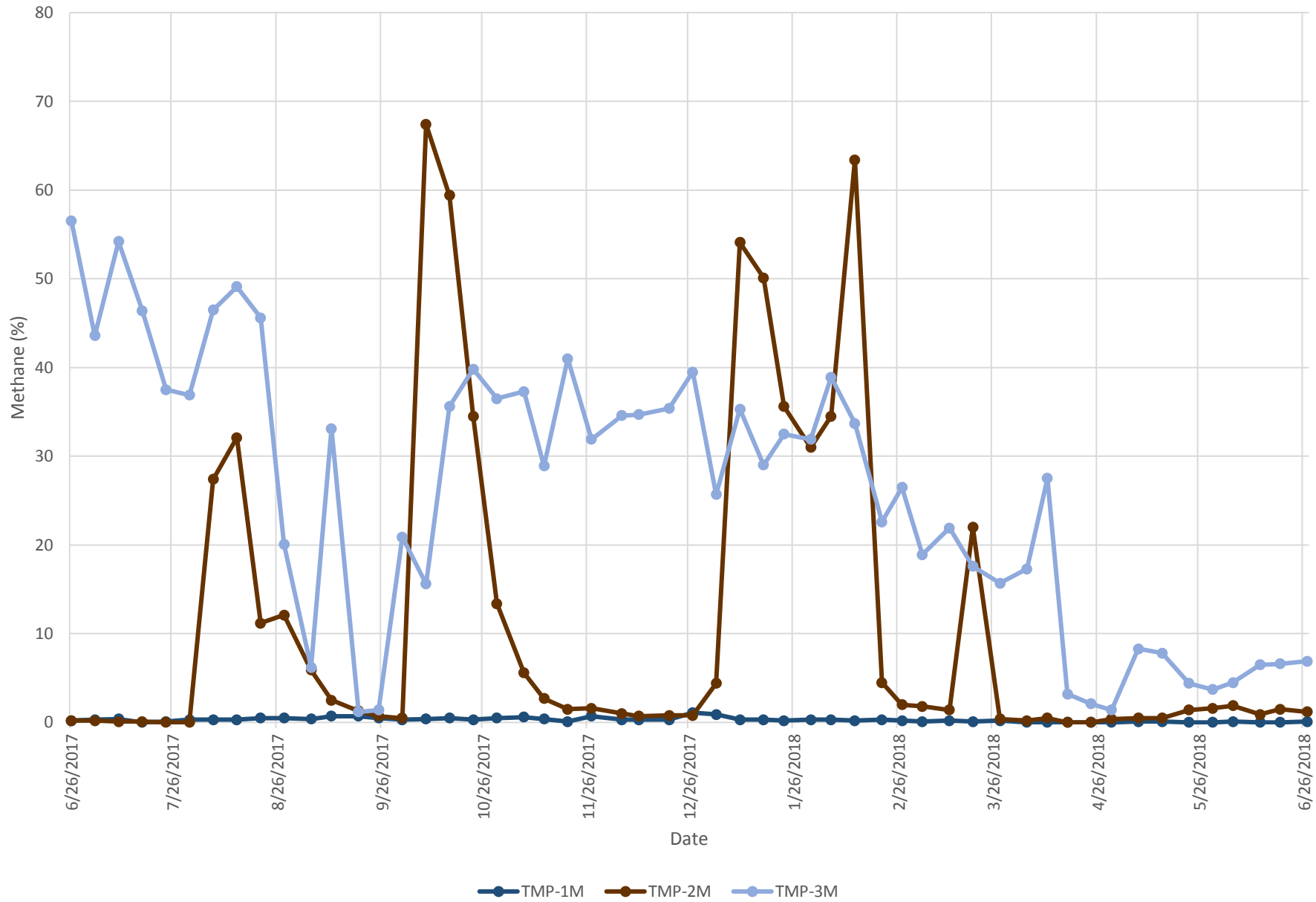

Deep Investigative Probes

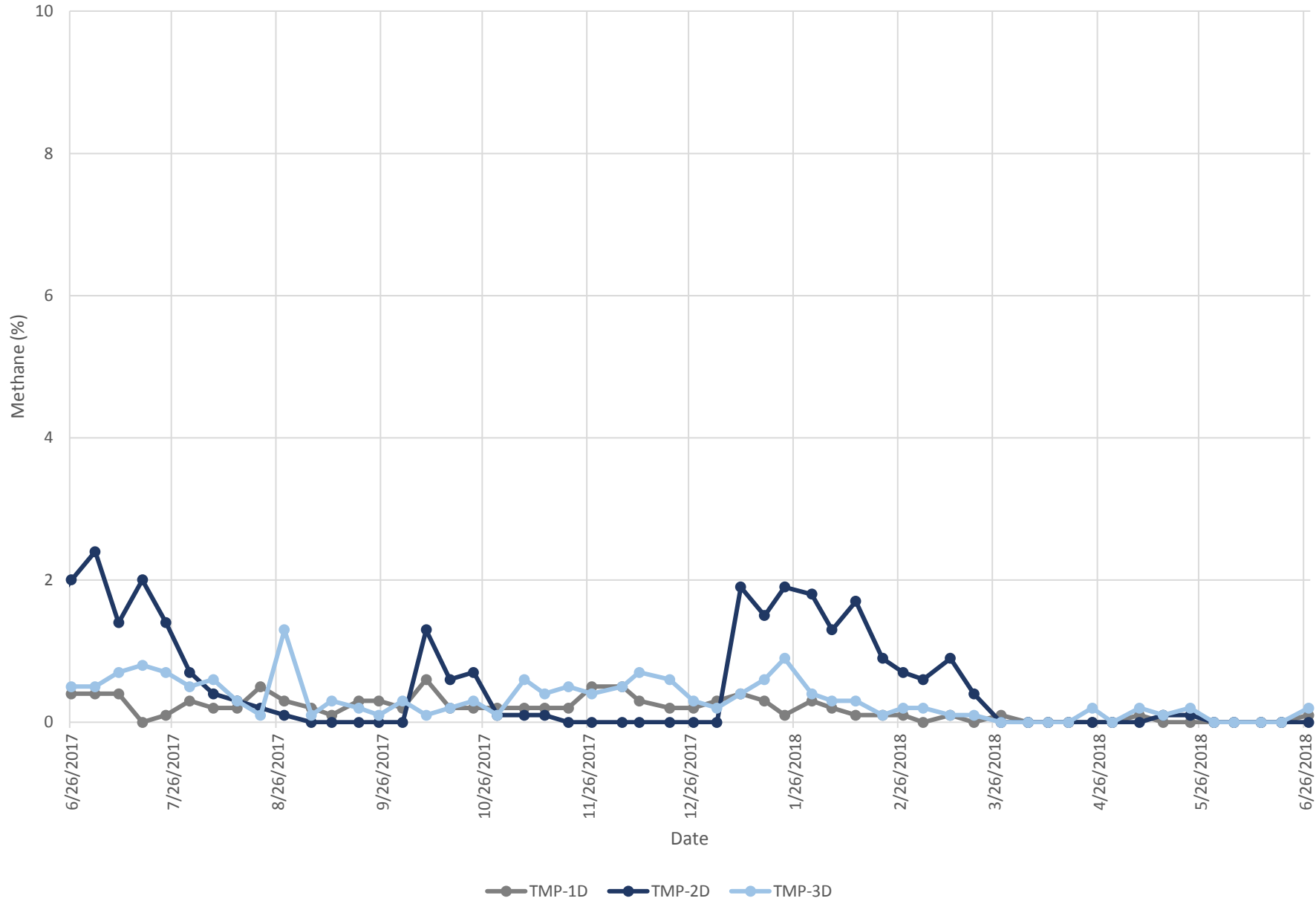



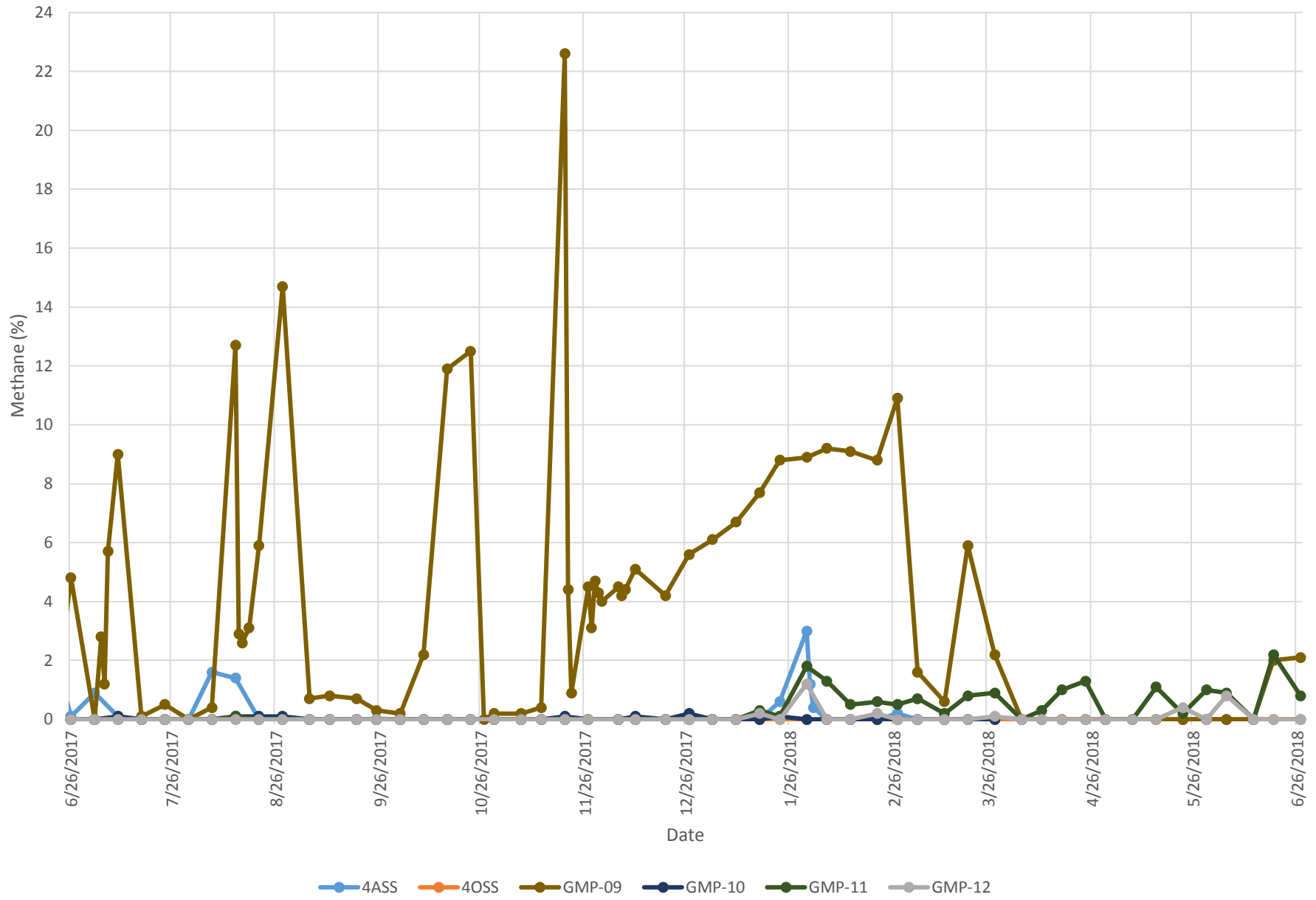

Public Safety Probes



APPENDIX C

INFRASTRUCTURE SITE PLAN, GAS MONITORING PROBE LOCATIONS

LEGEND

-  LFG WEEKLY MONITORING PROBE
-  LFG QUARTERLY MONITORING PROBE
-  PERMITTED WASTE LIMIT
-  PROPERTY LINE
-  QUADRANT BOUNDARIES

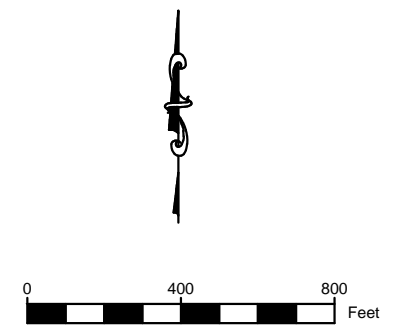
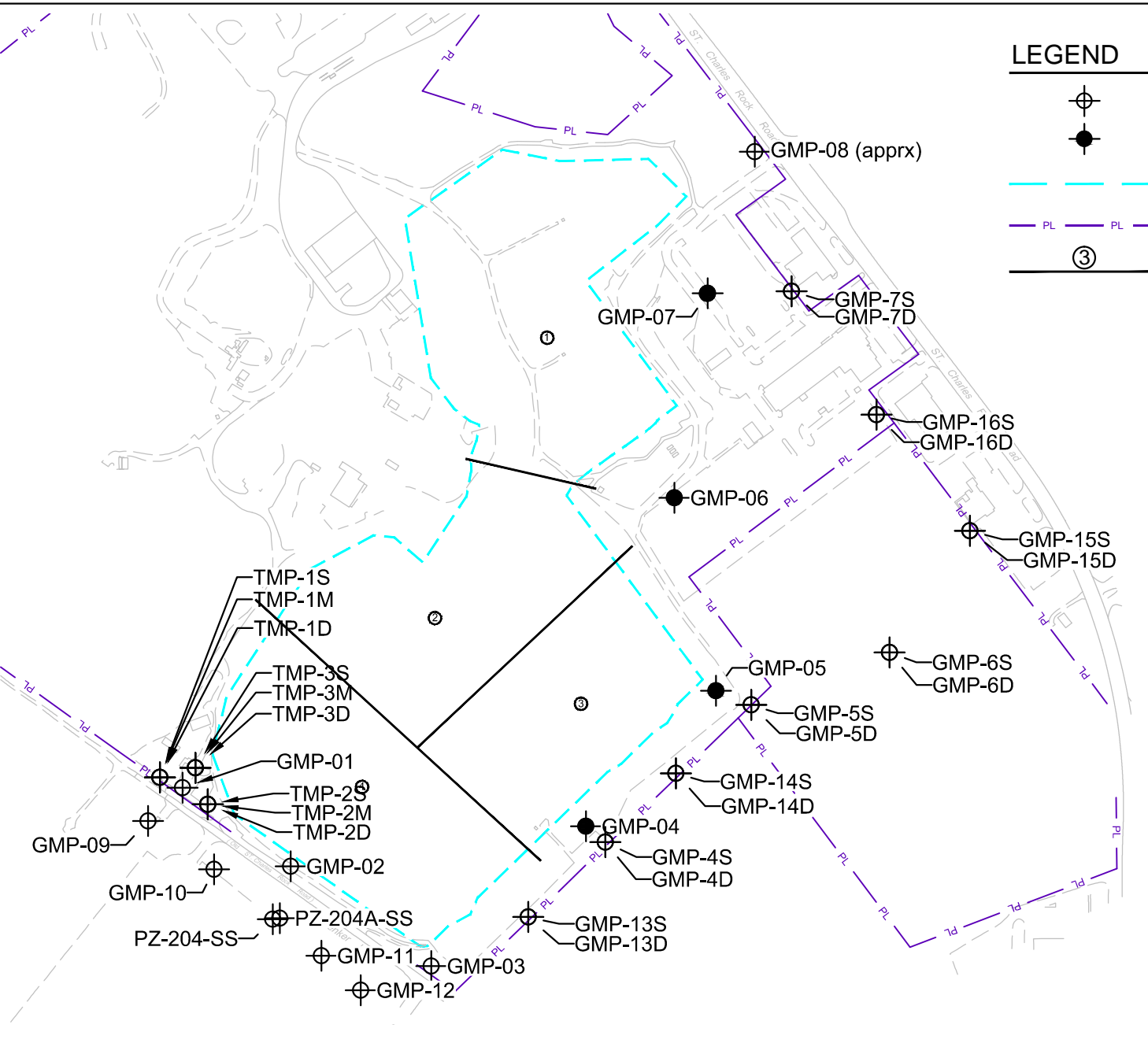

BRIDGETON LANDFILL LLC
13570 ST. CHARLES ROCK ROAD
BRIDGETON, MISSOURI 63044

BRIDGETON LANDFILL
SITE INFRASTRUCTURE



DECEMBER 2013
DESIGNED BY: PML
APPROVED BY: ---

DRAWING NO.:

001

GAS MONITORING PROBES

REVISION DATE

APPENDIX D

2017 GCCS IMPROVEMENTS

AS-BUILT DRAWINGS FOR THE

BRIDGETON LANDFILL

2017 GCCS IMPROVEMENTS

DECEMBER 2017
PREPARED FOR:

BRIDGETON LANDFILL, LLC

13570 ST. CHARLES ROCK ROAD
BRIDGETON, MISSOURI 63044



LOCATION MAP

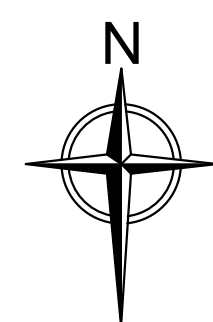

3377 HOLLENBERG DRIVE
BRIDGETON, MO 63044
TEL. (217) 483-3118

INDEX OF DRAWINGS

	TITLE PAGE
001	GCCS PLAN VIEW
002	DETAILS

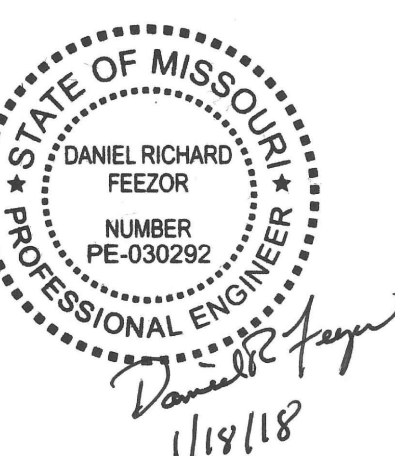



CURRENT FILL PROJECT BOUNDARY

LEGEND	
	SOLID WASTE BOUNDARY
	QUARRY WALL
	GAS EXTRACTION WELL
	PERIMETER GAS EXTRACTION WELL
	SURFACE EXTRACTION WELL
	CONDENSATE SUMP
	PERIMETER GAS EXTRACTION WELL
	GAS INTERCEPTOR WELL
	GAS INTERCEPTOR WELL/HEAT EXTRACTION POINT
	GAS EXTRACTION WELL WITH 4" STINGER
	INSTALLED 2017 GAS EXTRACTION WELL
	INSTALLED 4" LFG LATERAL
	INSTALLED 6" LFG LATERAL

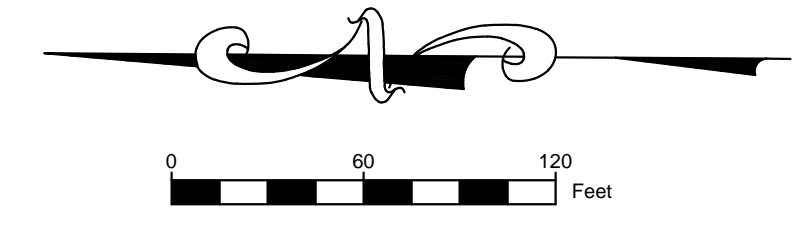

NOTES:		AERIAL TOPOGRAPHY PROVIDED BY COOPER AERIAL SURVEYS CO. AND IS DATED DECEMBER 2, 2016	
BRIDGETON LANDFILL, LLC 13570 ST. CHARLES ROCK ROAD BRIDGETON, MISSOURI 63044	BRIDGETON LANDFILL 2017 GCCS IMPROVEMENTS AS-BUILT DRAWINGS		DECEMBER 2017 DESIGNED BY: AMR APPROVED BY: DRF
GCCS PLAN VIEW		001	
PROJECT NO: BT-143	FILE PATH: D:\Inbox (Feeszor Engineering)\BT-143 (2017 GCCS Improvements)\AS-Built Drawings	REVISION	DATE

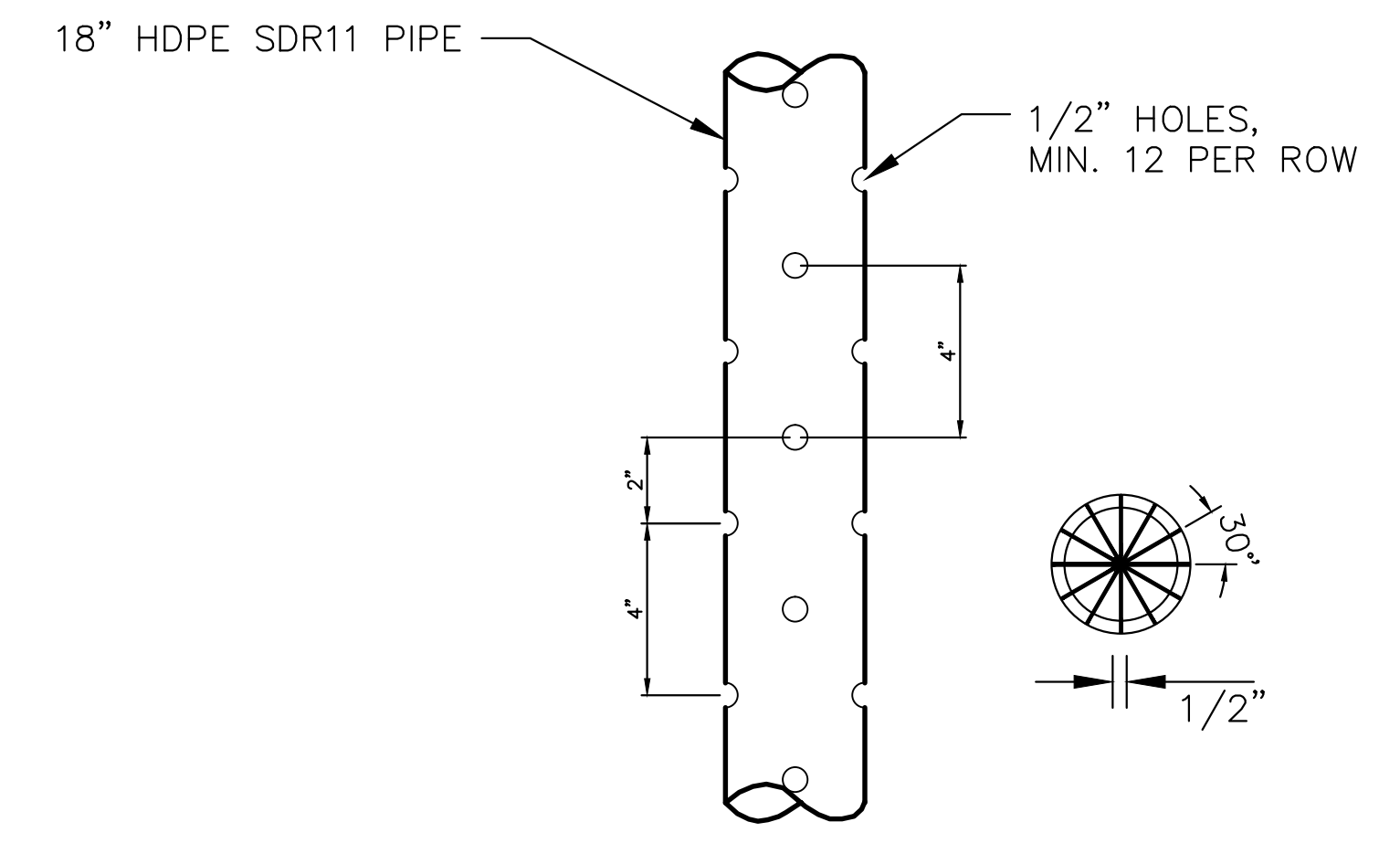
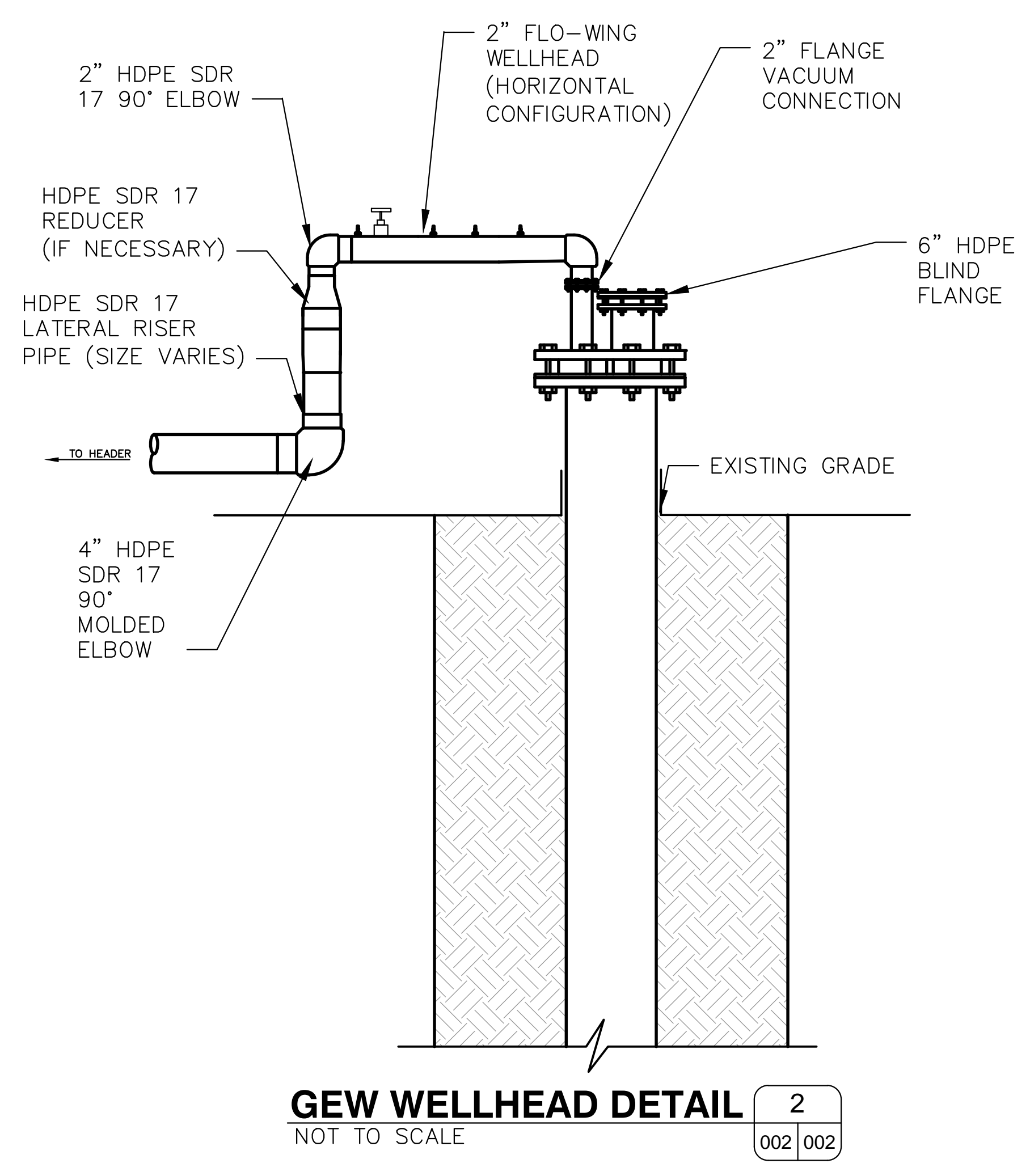
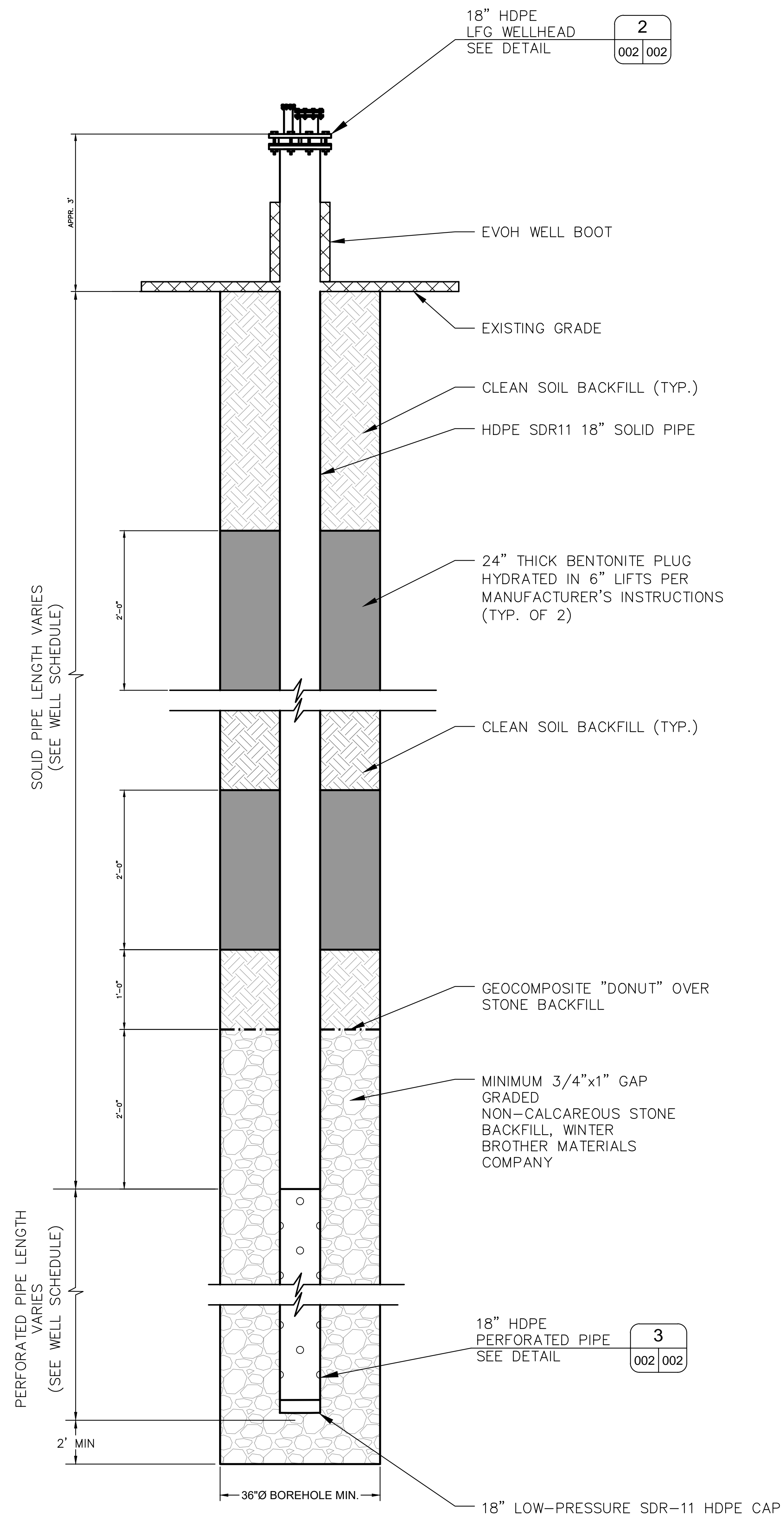

- NOTES:
1. PERFORATIONS SPACED 30" APART HORIZONTALLY.
 2. PERFORATIONS SPACED 4" APART VERTICALLY.
 3. 90° AND 270° ROWS STAGGERED 2" BELOW 0° AND 180° ROWS.
 4. THE MATERIAL OF CONSTRUCTION AND PERFORATION PATTERN WERE SPECIFIED BY BRIDGETON LANDFILL, LLC.

GEW WELLHEAD DETAIL 2
NOT TO SCALE 002|002

GEW PERFORATED PIPE DETAIL 3
NOT TO SCALE 002|002

- NOTES:
1. CONTRACTOR INSTALLED BRIDGETON LANDFILL TYPICAL WELLHEAD.

2017 WELL SCHEDULE										
WELL ID	Northing	Easting	As-Built Survey	Bottom of Boring	Quarry Bottom	Db	Solid Pipe	Solid Pipe	Dp	Thickness of
			(12/20/17)							
			(Feet MSL)	(Feet MSL)	(Feet MSL)	(Feet)	(Feet)	(Feet)	(Feet)	(Feet)
GEW-178	1,066,937.0	516,614.0	491.0	445.0	418.3	46	3	17	21	31
GEW-179	1,067,040.0	516,715.6	491.7	451.7	392.4	40	3	17	21	25
GEW-180	1,066,875.0	516,542.5	492.1	452.1	433.0	40	3	17	21	25
GEW-181	1,066,782.0	516,459.5	489.0	448.0	418.3	41	3	17	21	24
GEW-182	1,067,105.0	515,416.3	469.8	444.8	425.2	25	3	12	11	14
GEW-184	1,066,912.0	515,382.1	466.0	441.0	389.6	25	3	12	10	12
GEW-185	1,066,853.0	515,424.9	472.1	441.1	398.0	31	3	17	11	14
GEW-186	1,066,407.0	516,015.0	487.1	447.1	445.7	40	3	17	21	25
GEW-187	1,067,648.0	516,568.9	488.6	448.6	430.6	40	3	17	21	25
GEW-188	1,066,927.0	515,516.3	476.2	446.2	318.0	30	3	13	15	19

Notes: "Quarry Bottom" elevation taken from 1979 topography obtained from Aquaterra

- NOTES:
1. THE GAS WELL DEPTH, MATERIAL OF CONSTRUCTION, PERFORATION PATTERN AND BACKFILL MATERIAL WERE SPECIFIED BY BRIDGETON LANDFILL, LLC.

LFG EXTRACTION WELL DETAIL 1
NOT TO SCALE 001|002

NOTES:
AERIAL TOPOGRAPHY PROVIDED BY COOPER AERIAL SURVEYS CO. AND IS DATED DECEMBER 2, 2016

BRIDGETON LANDFILL, LLC 13570 ST. CHARLES ROCK ROAD BRIDGETON, MISSOURI 63044	BRIDGETON LANDFILL 2017 GCCS IMPROVEMENTS AS-BUILT DRAWINGS	DECEMBER 2017 DESIGNED BY: AMR APPROVED BY: DRP	DRAWING NO.: 002
GCCS DETAILS		FEEZOR ENGINEERING, INC.	REVISION DATE

PROJECT NO: ST-143 | FILE PATH: C:\Users\jason\Documents\143\2017\001\001.dwg | Report\Approved\02_A8.dwg