



August 14, 2020

Mr. Darrell Hartley
Permits Unit Chief
Waste Management Program
Division of Environmental Quality
Missouri Department of Natural Resources
1730 East Elm Street
Jefferson City, Missouri 65101

RE: Bridgeton Landfill and West Lake Landfill
Revised Incident Management Plan

Dear Mr. Hartley:

On behalf of Bridgeton Landfill, LLC., Feezor Engineering, Inc. (FEI) has prepared the enclosed revised Incident Management Plan (IMP) for the Bridgeton Landfill and portions of the West Lake Landfill.

As discussed during the June 17, 2020 quarterly IMP meeting with local and regulatory authorities, the plan has been revised to reflect changes to Bridgeton Landfill's gate numbering system and changes in emergency contacts.

Should you have any questions or comments, please contact the undersigned at your convenience.

Sincerely,

A handwritten signature in cursive script that reads "Andrew Wyatt".

Andrew Wyatt
Senior Hydrogeologist / Residuals Management Team Member



Attachments: Revised Incident Management Plan

Cc: Ally Cunningham – Lathrop Gage LLP
Eric Ballenger – Republic Services
Erin Fanning – Bridgeton Landfill, LLC
Mark Milward – St. Louis County Department of Public Health
Chris Nagel – MDNR WMP
Make Parris – MDNR WMP
Paul Rosasco – Engineering Management Support, Inc.
Michele Ryan – St. Louis County Office of Emergency Management
Dana Sincox – Bridgeton Landfill, LLC
Victoria Warren – Republic Services, Inc.



**INCIDENT MANAGEMENT PLAN WITH
CONTINGENCY PLAN AND EMERGENCY PROCEDURES**

BRIDGETON LANDFILL and WEST LAKE LANDILL

BRIDGETON, MISSOURI

Prepared For:

**Bridgeton Landfill, LLC
13570 St. Charles Rock Rd
Bridgeton, MO 63044**

**(March 30, 2020)
Revised August 14, 2020**

Prepared By:

**Feezor Engineering, Inc.
3377 Hollenberg Drive
Bridgeton, Missouri 63044**

**INCIDENT MANAGEMENT PLAN
WITH
CONTINGENCY PLAN AND EMERGENCY PROCEDURES**

**BRIDGETON LANDFILL AND WEST LAKE LANDFILL
BRIDGETON, MISSOURI**

Prepared for
Bridgeton Landfill, LLC
(March 30, 2020)
Revised August 14, 2020

Prepared by
Feezor Engineering, Inc.
3377 Hollenberg Dr
Bridgeton, MO 63044
Project BT-202

CONTENTS

LIST OF TABLES	iii
LIST OF FIGURES	iv
LIST OF APPENDICES	v
1 DEFINITIONS.....	1
2 INTRODUCTION	3
3 DESCRIPTION OF BRIDGETON LANDFILL AND WEST LAKE LANDFILL	6
4 INCIDENT PREVENTION	7
4.1 EXISTING PLANS AND PROGRAMS	7
4.2 ACCESS AND STAFFING	7
4.3 SURVEILLANCE	8
4.4 SAFETY DATA SHEETS	8
5 RESPONSE AND INCIDENT STRATEGIES.....	9
6 RESUMPTION AND RESTORATION	11
7 AFTER INCIDENT REPORTING	12
8 AMENDMENT OF PLAN	13
9 REFERENCES	14
TABLES	
FIGURES	
APPENDICES	

LIST OF TABLES

Table 1	Responsibilities and Contacts
Table 2	List of Available On-Site Resources
Table 3	Supporting Plans and Documents

LIST OF FIGURES

Figure 1	Facility Location
Figure 2	Facility Map
Figure 3	Fire Hydrant Locations
Figure 3A	Emergency Locator Map
Figure 4	Chemical Storage Areas
Figure 5	Emergency Access Road Plan Proposed Conditions
Figure 6	Emergency Access Road Plan Truck Schematics
Figure 7	Knife Gate Valve Location Map

LIST OF APPENDICES

- A Response and Incident Strategies
- B Facility Emergency Coordinator Checklist
- C Spill Prevention and Response for Leachate
- D On-Site Fire Hydrant Flow Test Reports

1 DEFINITIONS

Facility Emergency Coordinator	Bridgeton Landfill employee identified with the responsibility for initial assessment and coordinate of response activities with Regulatory and Local Authorities.
Incident	A situation that is non-routine or is anomalous and which poses a threat to the health and safety of on-site personnel or the public, or which may develop into such.
Incident Commander	A representative of a governmental emergency response agency to which all other respondent report.
Level 0 Incident	An incident that can be handled entirely by on-site Bridgeton Landfill, LLC personnel and equipment. In some cases, notification to local authorities and/or regulatory authorities may be necessary.
Level 1 Incident	An incident that requires the assistance of local authorities to remedy. The incident may pose potential harm to the life, safety, or health of on-site personnel.
Local Authorities	Parties that have a role or interest in emergency response including (but not necessarily limited to): local police and fire departments, emergency responders (i.e., EMS / paramedics / ambulance services), the St. Louis County Local Emergency Planning Committee, Lambert-St. Louis International Airport, and the City of Bridgeton.
Operable Unit 1 (OU-1)	Operable Unit 1 of the West Lake Landfill Superfund Site, which consists of two solid waste disposal areas (Areas 1 and 2) and a parcel of land known as the "Buffer Zone" in which radionuclides have been identified. Areas 1 and 2 and the Buffer Zone are depicted on Figure 2 .

Regulatory Authorities

Governmental agencies responsible for permitting and regulation of activities associated with, or affected by, the landfill. These include (but are not necessarily limited to): the Missouri Department of Natural Resources (MDNR), the St. Louis Metropolitan Sewer District (MSD), the United States Environmental Protection Agency (EPA), the St. Louis County Department of Health (DoH), and the Federal Aviation Administration (FAA).

2 INTRODUCTION

This Incident Management Plan (IMP) for the Bridgeton Landfill and portions of the West Lake Landfill describes plans to prevent incidents, required protocol for initial incident emergency calls, coordination of responses, and resumption of normal activities (in case of interruption). As used throughout this plan, the term “incident” means a situation that is non-routine or is anomalous and which poses a threat to the health and safety of on-site personnel or the public, or which may develop into such.

The West Lake Landfill Superfund Site (the “site”) is a 200-acre site located in the western portion of St. Louis County near the intersection of Interstate 70 and Interstate 270, approximately 1.5 miles east of the Missouri River (see **Figure 1**). The site is bounded to the east and northeast by St. Charles Rock Road (State Highway 115). Commercial and industrial properties bound the site immediately to the north, across St. Charles Rock Road to the north and east, and to the south. The site is bounded to the west by Old St. Charles Rock Road (now vacated) and the Earth City Industrial Park stormwater/flood control pond. The Earth City complex continues to the west and north of the stormwater/flood control pond and extends from the site to the Missouri River. Earth City is separated from the river by an engineered levee system owned and maintained by the Earth City Flood Control District.

The site consists of two separate landfills: the West Lake Landfill and the Bridgeton Landfill. West Lake Landfill includes four identified waste disposal areas: Radiological Area 1 (Area 1), Radiological Area 2 (Area 2), a closed demolition landfill, and an inactive sanitary landfill. Waste materials containing radionuclides have been identified in the two solid waste disposal areas designated as Areas 1 and 2, in which municipal solid waste (MSW) and industrial wastes were disposed from approximately the late 1940s or early 1950s until these areas ceased accepting waste in 1974. Based on the presence of radionuclides in Areas 1 and 2, EPA designated these two areas as Operable Unit 1 (OU-1) of the West Lake Landfill Superfund Site. The other areas were designated as part of Operable Unit 2 (OU-2).

The permitted Bridgeton Landfill, which includes the North and South Quarry areas, is also located at the site (see **Figure 2**) and has been designated as part of OU-2. In 1979, landfilling began in the North Quarry pit. Landfilling continued in this area until 1985, when the landfill underwent expansion to the southwest into the South Quarry pit. Bridgeton Landfill is currently an inactive landfill, having stopped receiving waste in December 2004 pursuant to an agreement with the City of St. Louis to reduce the potential for birds to interfere with airport operations.

Pursuant to a December 9, 2015 Unilateral Administrative Order for Removal Action (UAO), EPA required the named West Lake Landfill Superfund Site Operable Unit 1 Respondents (Cotter Corporation [N.S.L.] and Bridgeton Landfill, LLC) to prepare an Incident

Management Plan for OU-1 of the West Lake Landfill (EPA 2015). An IMP had previously been prepared by Civil and Environmental Consultants, Inc. (CEC) to prevent and respond to incidents specifically related to Bridgeton Landfill (CEC 2015). Rather than prepare a separate IMP for West Lake Landfill, this existing Bridgeton Landfill IMP was modified to address potential incidents that might occur within or related to West Lake Landfill OU-1. The IMP was first revised to incorporate OU-1 on March 21, 2016 (EMSI 2016). This “unified” IMP was subsequently revised on several occasions in response to input from local and regulatory authorities.

As specified in the May 6, 2019 Remedial Design Statement of Work (SOW) for OU-1, incident management for OU-1 will henceforth be addressed in the Emergency Response Plan (ERP) required by SOW Paragraph 5.7(b) (EPA 2019a). The OU-1 ERP was submitted to the EPA on September 25, 2019 (Parsons 2019) and approved by the EPA on October 15, 2019 (EPA 2019b). Accordingly, this IMP was revised on March 30, 2020 to address only the non-OU-1 portions of the site, including the OU-2 waste disposal areas – Bridgeton Landfill, the closed demolition landfill, and the inactive sanitary landfill – and other site structures and facilities.

At the Bridgeton Landfill, risks can result from the use of large mobile and stationary equipment, handling of combustible materials, and the management of waste byproducts such as decomposition gases and liquid leachate. Further, a recognized exothermic chemical reaction (referred to as a “subsurface reaction,” or SSR) is occurring within a portion of the South Quarry area of the Bridgeton Landfill. Such heat-generating reactions can increase the potential hazards and the likelihood of an incident. An Operation, Maintenance, and Monitoring (OM&M) Plan was submitted separately to the MDNR to describe special observations and preventative maintenance procedures that Bridgeton Landfill personnel are implementing to manage the Bridgeton Landfill and SSR (CEC 2019). The OM&M Plan requires that monitoring and work activity reports be generated and submitted to the MDNR, allowing constant tracking of the status of the SSR. The most recent version of the OM&M Plan was approved by the MDNR on September 18, 2019 (MDNR 2019).

In addition to the OM&M Plan, the Bridgeton Landfill is required to have various spill prevention plans, leachate treatment and handling protocols, surface water management plans, and air quality plans. These plans can be found at the Bridgeton Landfill facility office.

If a trigger value is exceeded in the North Quarry area of the Bridgeton Landfill, procedures outlined in the decision tree presented in Figure 1 of the facility’s Inert Gas Injection Work Plan for Hot Spot Remediation will be implemented (SCS 2016). A copy of this Inert Gas Injection Work Plan can be found at the Bridgeton Landfill facility office.

Bridgeton Landfill creates, stores, treats, and disposes of leachate as part of its operation. Chemicals associated with leachate treatment are located in storage areas identified in **Figure 4**. Constituents contained in the leachate have, at times, exceeded levels at which it could be classified as a hazardous waste in accordance with the Code of Federal Regulations

(CFR) Part 261. Specifically, some of the leachate has occasionally exceeded the Resource Conservation and Recovery Act (RCRA) toxic characteristic leaching procedure (TCLP) hazardous threshold for benzene, which corresponds to the waste code D018. Leachate is currently treated in a Clean Water Act-permitted waste water treatment unit and the facility is a Conditionally Exempt Small Quantity Generator. However, as a proactive measure, Bridgeton Landfill implemented contingency planning, training, and safety measures meeting the requirements applicable to a large quantity hazardous waste generator (40 CFR Part 262), including certain provisions of 40 CFR Part 265. As such, this IMP has also been developed to meet the requirements of 40 CFR 265, Subpart D – Contingency Plan and Emergency Procedures.

The remainder of this IMP is composed of the following sections:

- 3.0 Description of Bridgeton Landfill and West Lake Landfill – Location, access, size, and facilities are described.
- 4.0 Incident Prevention – Describes measures for incident prevention, assignment of Emergency Coordinators, and communication and coordination with Regulatory and Local Authorities.
- 5.0 Response and Incident Strategies – Presents response scenarios for identified potential incidents.
- 6.0 Resumption and Restoration – In the case of service interruptions, this section describes the process for resuming operations, including regulatory approvals.
- 7.0 After-Incident Reporting – Describes the reporting actions to be taken after an incident has occurred at the site.
- 8.0 Amendment of Plan – Describes the frequency and process for updating and amending the IMP.

3 DESCRIPTION OF BRIDGETON LANDFILL AND WEST LAKE LANDFILL

Bridgeton Landfill is an inactive municipal solid waste landfill located at 13570 St. Charles Rock Road in Bridgeton, Missouri (see **Figure 1**). The site was formerly mined for limestone, resulting in large, open pits which were over 200 feet deep. Beginning in the late 1940s or 1950s, portions of the property were backfilled with municipal wastes., industrial wastes, and construction and demolition debris. Landfill operations ceased in 2004.

The Bridgeton Landfill covers about 52 acres of the larger 214-acre property that comprises the West Lake Landfill Superfund Site and is the primary focus of this IMP. In addition, a hot mix asphalt batch plant, a waste transfer station, a closed demolition landfill, an inactive sanitary landfill, and many appurtenant features are presents on the site property. The facility layout and access are illustrated on **Figure 2**.

Although active landfilling operations have ceased, many other activities are occurring at the Bridgeton Landfill, including:

- Placement and maintenance of cover materials;
- Collection, management, and destruction of landfill decomposition gas;
- Generation, collection, storage, treatment, and disposal of landfill leachate; and
- Operation of a waste transfer station, at which waste is transferred from small local collection trucks into large long-haul trucks for transportation to a remote landfill.

When waste material decomposes, biological processes increase its temperature and produce combustible gases, primarily methane. Portions of the Bridgeton Landfill's South Quarry Area are experiencing higher-than-typical temperatures resulting from a heat-generating subsurface reaction (the SSR) taking place beneath the landfill surface within the waste mass. Heightened monitoring and maintenance of the facility is required to mitigate the SSR and its effects.

4 INCIDENT PREVENTION

4.1 Existing Plans and Programs

Many voluntary and required programs and documents are used at the Bridgeton and West Lake Landfills to minimize hazards and protect the health and safety of both on-site personnel and the public at large. A partial list and description of these programs and documents is provided below. A complete list, including the locations where copies of these documents are maintained at the site, is presented in **Table 3**.

Solid Waste Disposal Operating Permit #118912 (MDNR 1985)

This permit and accompanying permit application documents govern the former operation and current closure and post-closure activities at the Bridgeton Landfill. These documents are available at the Bridgeton Landfill office.

Bridgeton Landfill Health and Safety Plan (HASP) (Bridgeton Landfill 2016)

This site-specific plan details safety protocols. The HASP focuses on the specific health and safety hazards that are related to working in and around a landfill and requires landfill personnel to receive certain training pursuant to Occupational Health and Safety Administration (OSHA) regulations (among other requirements) in advance of performing certain tasks.

Bridgeton Landfill Operation, Maintenance, and Monitoring Plan (OM&M Plan) (CEC 2019)

As noted in **Section 2.0** above, an SSR is occurring within a portion of the South Quarry of the Bridgeton Landfill. The OM&M Plan describes special observations and preventative maintenance procedures which are currently being implemented by Bridgeton Landfill personnel. Among other things, the OM&M Plan requires that monitoring and work activity reports be routinely generated and submitted to the MDNR, allowing constant tracking of the status of the SSR.

In addition to the above documents, Bridgeton Landfill is required to have various spill prevention plans, leachate treatment and handling protocols, surface water management plans, and air quality plans. These plans can be found at the Bridgeton Landfill office.

4.2 Access and Staffing

The Bridgeton Landfill is staffed 24 hours a day, 7 days a week, including holidays. During business hours, Bridgeton Landfill is staffed by technicians, specialists, managers, and third-party consultants/contractors – all of whom have received Bridgeton Landfill’s site-specific contractor training, which includes an overview of health and safety and emergency response measures. In addition, during the night shift, third-party contractors are

employed to complete various tasks, including hazard identification, at and around the site. Finally, a manager is always on call to respond to incidents (see **Table 1** for contact information). This manager is trained in all elements of this IMP, such that the IMP will be implemented 24 hours a day ,7 days a week.

4.3 Surveillance

The Bridgeton Landfill currently has continuous, controlled access and a 24/7 routine inspection monitoring program in place. These are detailed in the confidential *Security and Access Control Program* (Bridgeton Landfill 2018), a copy of which is maintained at the Bridgeton Landfill office.

4.4 Safety Data Sheets

A Safety Data Sheet (SDS) library is available for chemicals that are used and stored on site at the Bridgeton Landfill. The site maintains an electronic database that allows the Facility Emergency Coordinator or other personnel to easily access the SDS and other information related to these chemicals. A hard copy of the site's SDS library is also maintained at the Bridgeton Landfill office. The electronic database and hard copy are available upon request.

5 RESPONSE AND INCIDENT STRATEGIES

An “incident” is a situation that is non-routine or is anomalous situation and which poses a threat to the health and safety of on-site personnel or to the public, or which may develop into such. Bridgeton Landfill has designated a Facility Emergency Coordinator who is responsible for determining if a situation rises to the level of an incident. The Facility Emergency Coordinator and other responsible parties are specified on **Table 1**. The Facility Emergency Coordinator will at all times be a Bridgeton Landfill, LLC employee who is thoroughly familiar with 1) all aspects of this plan, 2) all operations and activities at the site, 3) the location and characteristics of hazardous or potentially hazardous materials at the site, 4) the location of all relevant records at the site, and 5) the site layout.

When an incident occurs, the Facility Emergency Coordinator will make an initial assessment of the severity of the incident and classify it as Level 0 or Level 1 based on the nature of the incident (see definitions in **Section 1.0** above). Depending on the severity of the incident, regulatory authorities and/or local authorities may become involved. A checklist of some of the important incident management steps to be taken by the Facility Emergency Coordinator is presented in **Attachment B**. If 9-1-1, the EPA spill line, or the MDNR spill line is called regarding an incident at Bridgeton Landfill or West Lake Landfill (excluding OU-1), it is requested that the operator notify the Facility Emergency Coordinator or Alternate (see **Table 1**). If the MDNR spill line is called, it is understood that the Department will contact its Waste Management Program (WMP). Regardless of which emergency number is contacted – 9-1-1, EPA spill line, or MDNR spill line – it is understood that the WMP will contact the Facility Emergency Coordinator or Alternate immediately after the WMP is contacted.

At this time, identified potential incidents at the non-OU-1 portions of the site fall into one of the following categories:

- Incoming call to 9-1-1 / EPA spill line / MDNR spill line regarding Bridgeton or West Lake Landfill (non-OU-1);
- Bridgeton Landfill surface fire (vegetation or landfill fire);
- Bridgeton Landfill personal injury – man down / personnel contamination;
- Bridgeton Landfill sudden waste movement; and
- Bridgeton Landfill leachate release.

Site entrances are illustrated on the attached **Figure 2**. Evacuations, if necessary, may be made at any of these entrances. Internal communications are provided to appropriate facility personnel through two-way radios or cell phones. In the event of an emergency or required response or evacuation, the radio-equipped personnel will circulate the facility to provide appropriate notifications.

First responders are also expressly permitted to gain access to the site using emergency measures (e.g., cutting gate locks).

Figure 5 illustrates the roads around the site that are constructed on native ground and lists names for each road. Signage has been installed around the facility delineating native versus non-native roads, fire hydrant locations, and road names to provide first responders with visual references in the field. Additional alternate entrances are labeled on **Figure 5**. AutoTURN® software was used to simulate the required turn radius of emergency vehicles. Emergency vehicle dimensions input into AutoTURN® are illustrated on **Figure 6**. **Figure 7** illustrates the locations of stormwater knife gates located around the Bridgeton Landfill. Stormwater knife gate procedures are included in the response and incident strategies presented in **Attachment A**.

Attachment A presents the response and incident strategies for each of potential incidents listed above, including the procedures for notification by Bridgeton Landfill personnel to local authorities and regulatory authorities.

In the event of an incident that could impact the health or safety of adjacent property owners or the community, the St. Louis Office of Emergency Management (OEM) will be contacted to coordinate community notification efforts.

6 RESUMPTION AND RESTORATION

Severe incidents could result in damage to facility infrastructure or an interruption in maintenance activities or operation of the transfer station. Bridgeton Landfill has ongoing retention agreements with third-party contractors who can assist with restoration of critical site operation and maintenance functions.

In cases of Level 1 incidents, the Incident Commander will be involved in the decision and time of resumption of activities. Restoration will be coordinated with the MDNR and/or EPA so that the site meets all applicable requirements.

In case of damage to equipment, Bridgeton Landfill personnel will follow the applicable provisions of 40 CFR 265.196 regarding inspection, return-to-service, and certification of major repairs to any damaged equipment that has resulted in a release of a regulated substance. All emergency equipment listed in this plan will be replaced or cleaned and fit for its intended use before operations are resumed. Contaminated materials and personnel protective equipment (PPE) will be properly characterized and managed.

7 AFTER INCIDENT REPORTING

As soon as reasonably possible after an incident that requires the implementation of the procedures in this plan, the Facility Emergency Coordinator will prepare a written report that records the time, date, and details of the incident. At a minimum, this report will include:

- The name, address, and contact information for the site;
- The date, time, and type of incident (e.g., fire, explosion, injury, etc.);
- The name and quantity of hazardous materials released as a result of the incident, if any, as well as the estimated quantity and disposition of any recovered materials;
- The nature and extent of injury to on-site personnel, if any;
- An assessment of actual or potential hazards to human health or the environment; and
- A description of the steps taken to address the incident and to ensure the health and safety of on-site personnel and the public.

Within 15 days of a Level 1 incident, the Facility Emergency Coordinator will submit this report to EPA, MDNR, and, as appropriate, local authorities. In the case of a Level 0 incident, the after-incident report may be submitted to EPA, MDNR, or local authorities at the discretion of the Facility Emergency Coordinator, or as circumstances may otherwise dictate. In all cases, a copy of the report will be retained on-site in a location accessible to Bridgeton Landfill employees.

8 AMENDMENT OF PLAN

This plan will be review and amended, if necessary, whenever:

- Applicable regulations are revised;
- The plan fails in an emergency;
- The facility changes its design, construction, operations, maintenance, or other circumstances in a way that materially increases the potential for fires, explosion, or releases of hazardous waste or hazardous waste constituents, or changes the response necessary in an emergency;
- As deemed appropriate by Bridgeton Landfill personnel or the Facility Emergency Coordinator;
- Upon request/input of regulatory authorities;
- The list of emergency coordinators changes; and/or
- The list of emergency equipment changes.

In addition, Bridgeton Landfill holds quarterly meetings with the various first responders designated by local authorities to discuss site activities and incident response procedures.

Any proposed revision or updates to this plan will be provided to local responders, MDNR, and EPA for review, comment, and EPA approval.

9 REFERENCES

- Bridgeton Landfill. 2016. Bridgeton Landfill Health and Safety Plan (HASP). Prepared by Bridgeton Landfill, LLC.
- Bridgeton Landfill. 2018. Security and Access Control Program, Bridgeton Landfill (Confidential). Prepared by Bridgeton Landfill, LLC. July 19, 2018.
- Bridgeton Landfill. 2019. Incident Management Plan and Contingency Plan and Emergency Procedures, Bridgeton Landfill and West Lake Landfill. Prepared by Bridgeton Landfill, LLC. July 24, 2019.
- CEC. 2015. Incident Management Plan with Contingency Plan and Emergency Procedures, Bridgeton Landfill. Prepared by Civil & Environmental Consultants, Inc. June 10, 2015.
- CEC. 2019. Operation, Maintenance, and Monitoring Plan. Prepared by Civil & Environmental Consultants, Inc. August 16, 2019.
- EMSI. 2016. Incident Management Plan and Contingency Plan and Emergency Procedures, Bridgeton Landfill and West Lake Landfill. Prepared by Engineering Management Support, Inc. March 21, 2016.
- EPA. 2015. Unilateral Administrative Order (UAO) for Removal Action. U.S. Environmental Protection Agency, Region 7. Docket No. CERCLA-07-2016-0002. December 9, 2015.
- EPA. 2019a. Remedial Design Statement of Work (SOW), Operable Unit 1, West Lake Landfill Superfund Site. In: Third Amendment to Administrative Settlement Agreement and Order on Consent (ASAOC). U.S. Environmental Protection Agency, Region 7. Docket VII-93-F-0005. May 6, 2019.
- EPA. 2019b. Letter Re: Emergency Response Plan dated September 25, 2019. United States Environmental Protection Agency Region 7. October 15, 2019.
- MDNR. 1985. Solid Waste Disposal Operating Permit #118912. Issued by Missouri Department of Natural Resources. November 18, 1985.
- MDNR. 2019. Letter Re: Revised Operation, Maintenance, and Monitoring Plan, Three Volumes, Bridgeton Landfill. Missouri Department of Natural Resources Waste Management Program. September 18, 2019.
- Parsons. 2019a. Emergency Response Plan, West Lake Landfill Superfund Site Operable Unit 1. Prepared by Parsons Corporation. September 25, 2019.
- SCS. 2016. Corrective Action Measures – Inert Gas Injection Work Plan for Hot Spot Remediation. Prepared by SCS Engineers. December 16, 2016.

TABLES

- 1** Responsibilities and Contacts
- 2** List of Available On-Site Resources
- 3** Documents and Plans

Table 1
Responsibilities and Contacts
Bridgeton Landfill and West Lake Landfill
Incident Management Plan

Primary Emergency Contact - Dial 9-1-1	
Bridgeton Landfill Site Personnel - 13570 St. Charles Rock Road, Bridgeton, MO 63044	
Facility Emergency Coordinator	Erin Fanning Office: (314) 744-8165 Cell: (209) 227-9531
Alternate Emergency Facility Coordinator	Mike Lambrich Office: (314) 744-8175 Cell: (314) 683-3921
Alternate Emergency Facility Coordinator	Matt Stewart Office: (314) 656-2130 Cell: (314) 477-6140
Regulatory Authorities	
MDNR Waste Management Program - Compliance / Enforcement Section	Mike Parris Office: (573) 526-3918 Cell: (573) 680-6669
MDNR Waste Management Program - Director	Chris Nagel Office: (573) 751-5401 Cell 1: (573) 680-5146 Cell 2: (573) 690-5371
Missouri Department of Health and Senior Services	Keith Henke Cell: (573) 645-8943
MDNR - Environmental Emergency Response (Spill Line)	Hot Line: (573) 634-2436
MDNR - Environmental Emergency Response - St. Louis Region - Route 66	Mike Ruddy Office: (636) 938-7809 Cell: (314) 640-5198
St. Louis County Department of Health	Mark Millward Office: (314) 615-4116 Cell: (314) 520-1373
EPA Region 7 - On-Scene Coordinator	Tom Mahler Cell: (816) 604-0546
EPA Region 7 Spill Line	(913) 281-0991
Local Authorities	
Robertson Fire Dept.	Maynard Howell - Ass. Fire Chief Cell: (314) 575-5011
Pattonville Fire Dept.	Battalion Chief (Primary Contact) Cell: (314) 393-4802 Jim Usry, Assistant Fire Chief (Secondary Contact) Cell: (314) 393-4807 Office: (314) 739-3118

Table 1
Responsibilities and Contacts
Bridgeton Landfill and West Lake Landfill
Incident Management Plan

Local Authorities (Continued)	
Bridgeton Police Dept.	Chief Hood (Primary Contact) Cell: (314) 420-9112 Major Mossotti (Secondary Contact) Cell: (314) 602-3632
St. Louis County Office of Emergency Management (OEM)	Michele Ryan - LEPC Chair Office: (314) 615-9508 Bureau of Communications 24/7 Emergency: (314) 615-5360
Other Contacts	
SSM Health DePaul Hospital	(314) 344-6000
SSM Health St. Joseph Hospital - St. Charles	(636) 947-5000
National Response Center	(800) 424-8802

Table 2
List of Available On-Site Resources
Bridgeton Landfill and West Lake Landfill
Incident Management Plan

Resource	Quantity
Fire Hydrants	4 (see Figure 3A)
Soil Stock Pile	10,000 c.y. (see Figure 3)
Bulldozers	2
Water Truck (3,500-gal. with Cannon)	1
Water Truck Adapter to 5-in. Storz Fitting	1
Excavators	2
Spill Cleanup Kits*	18
Eye Wash Station*	8
Portable Fire Extinguishers*	66
Knife Gates	18
Vacuum Trucks	1
ATVs (2-Man with Tool Bed)	7
ATVs (4-Man with Tool Bed)	1
Aluminized Approach Suits	2
PVC Flame-Resistant Hot Liquid Suits	~30
UltraRAE 3000 Benzene-Specific Photoionization Detector (PID) Meter	1
RKI GX-2009 Portable 4-Gas Meters	15
RKI GX-6000 Portable 5-Gas Meter w/ Benzene-Specific PID Meter	1
Class A SFFF (Structural Fire Fighting Foam), 5-gal. Containers**	40

Note: Bridgeton Landfill routinely maintains the heavy- and light-duty equipment listed above.

* At all facility vehicles, each flare yard, leachate loadout, and MBI maintenance building.

** At Leachate Pretreatment Plant in storage bay on east side of building (see Figure 3).

Table 3
Documents and Plans
Bridgeton Landfill and West Lake Landfill
Incident Management Plan

Document	Location
MDNR Solid Waste Disposal Operating Permit #118912	Bridgeton Landfill Office
Bridgeton Landfill Health and Safety Plan (HASP) 2016	Bridgeton Landfill Office
Bridgeton Landfill Operation Maintenance and Monitoring Plan (OM&M Plan) Prepared August 16, 2019; Approved September 18, 2019	Bridgeton Landfill Office

FIGURES

- 1** Facility Location
- 2** Facility Map
- 3** Fire Hydrant Locations
- 3A** Emergency Locator Map
- 4** Chemical Storage Areas
- 5** Emergency Access Road Plan – Proposed Conditions
- 6** Emergency Access Road Plan – Truck Schematics
- 7** Knife Gate Valve Location Map

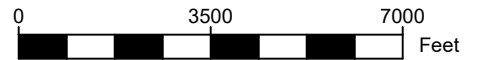
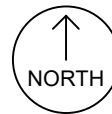
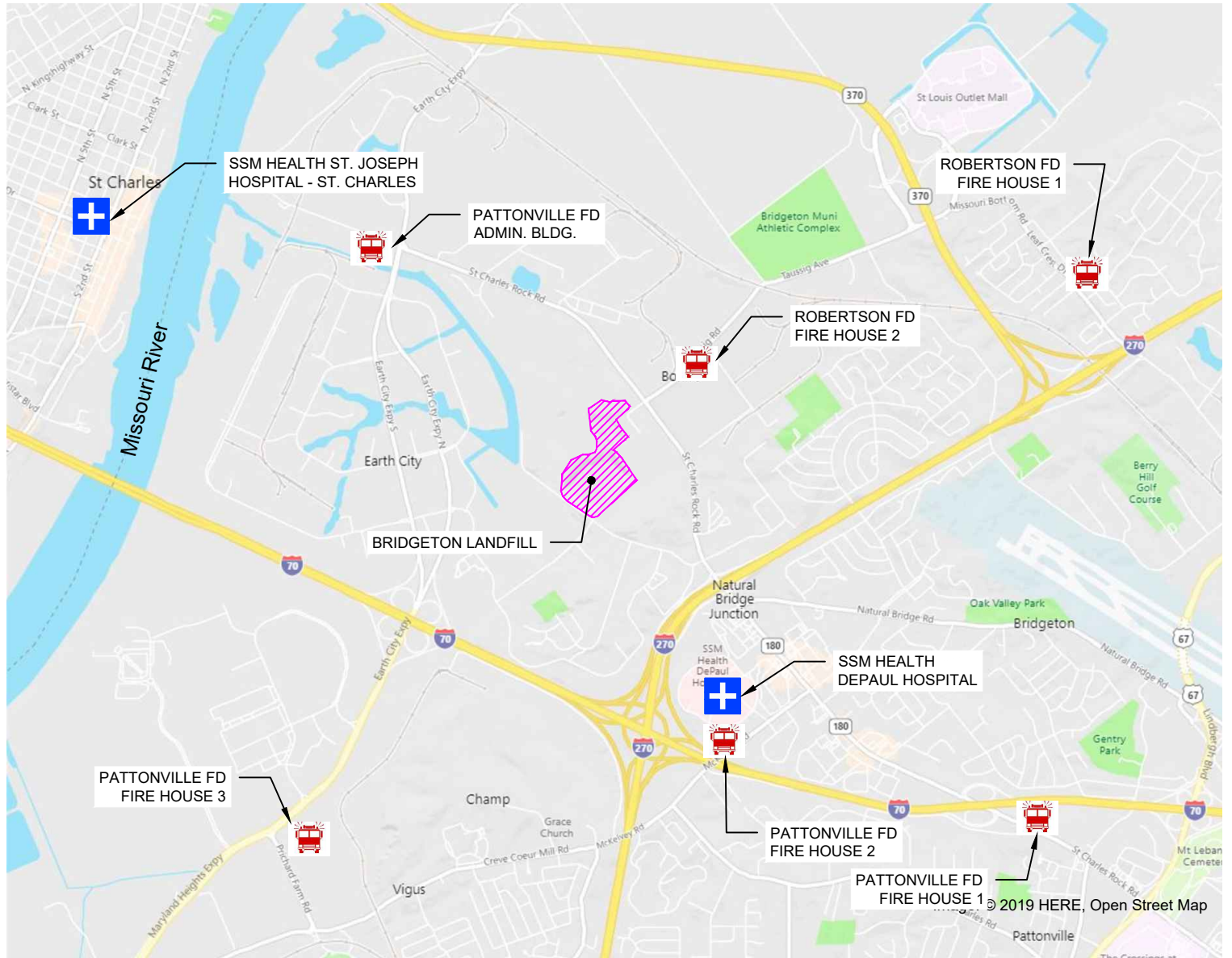

NOTE:

- 1) BASED ON FIGURES ORIGINALLY PREPARED BY CIVIL & ENVIRONMENTAL CONSULTANTS, INC. AND PRESENTED IN THE MARCH 28, 2019 INCIDENT MANAGEMENT PLAN.

PREPARED BY



3377 Hollenberg Dr, Bridgeton, MO 63044, Ph: 217-483-3118
 Missouri State Certificate Of Authority #: E-200912211

PROJECT

BRIDGETON/WEST LAKE LANDFILL
 INCIDENT MANAGEMENT PLAN (IMP)
 BRIDGETON, ST. LOUIS COUNTY, MO

PREPARED FOR

BRIDGETON/WEST LAKE LANDFILL
 13570 ST. CHARLES ROCK ROAD
 BRIDGETON, MISSOURI 63044

DRAWING TITLE

FIGURE 1 FACILITY LOCATION

PROJECT NUMBER: BT-202 | FILE PATH: C:\Users\plins\Dropbox (Feezor Engineering)\Bridgeton\BT-202 (Incident Management Plan)\2019\to Be Filed\figures-1-1-7\Fig-1-Fac-Loc 2

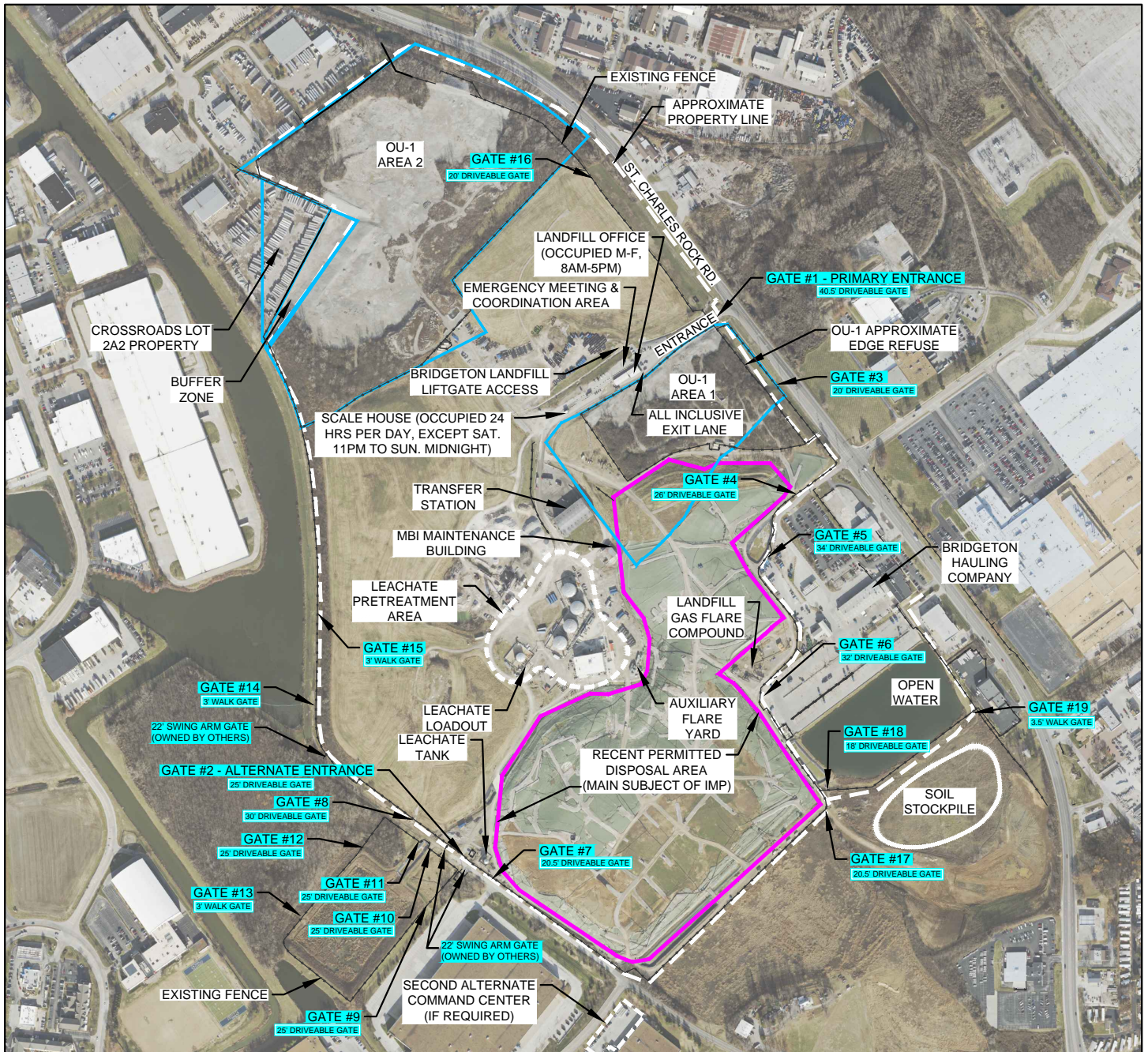

NOTES:

- 1) AERIAL IMAGERY PROVIDED BY COOPER AERIAL SURVEYS, INC. AND IS DATED DECEMBER 12, 2018
- 2) BASED ON FIGURES ORIGINALLY PREPARED BY CIVIL & ENVIRONMENTAL CONSULTANTS, INC. AND PRESENTED IN THE MARCH 28, 2019 INCIDENT MANAGEMENT PLAN.
- 3) A THIRD ALTERNATE COMMAND CENTER (IF REQUIRED) WOULD BE LOCATED AT THE PATTONVILLE FIRE PROTECTION DISTRICT ADMINISTRATIVE OFFICE AT 13900 ST. CHARLES ROCK ROAD.

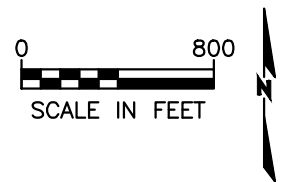

PREPARED BY



3377 Hollenberg Dr, Bridgeton, MO 63044, Ph: 217-483-3118
Missouri State Certificate Of Authority #: E-200912211

PROJECT

BRIDGETON/WEST LAKE LANDFILL
INCIDENT MANAGEMENT PLAN (IMP)
BRIDGETON, ST. LOUIS COUNTY, MO

PREPARED FOR

BRIDGETON/WEST LAKE LANDFILL
13570 ST. CHARLES ROCK ROAD
BRIDGETON, MISSOURI 63044

DRAWING TITLE

FIGURE 2 FACILITY MAP

PROJECT NUMBER: BT-202 | FILE PATH: C:\Users\User\Dropbox (Feezor Engineering)\Bridgeton\BT-202 (Incident Management Plan)\2019\To Be Filed\figures\1-1-7\Fig-2-Facility

LEGEND

BULK STORAGE CONTAINERS

- 1 ■ - ABOVEGROUND DIESEL FUEL STORAGE TANK - 6000 GAL
- 2 ■ - ABOVEGROUND DIESEL FUEL STORAGE TANK - 1000 GAL
- 3 ■ - ABOVEGROUND DIESEL FUEL STORAGE TANK - 1000 GAL
- 4 ■ - ABOVEGROUND DIESEL FUEL STORAGE TANK - 1000 GAL
- 5 ■ - ABOVEGROUND GASOLINE FUEL STORAGE TANKS - 29 GAL (3)
- 6 ■ - PROPANE STORAGE TANK - 500 GAL
- 7 ■ - MUNICIPAL CLASS-A FOAM

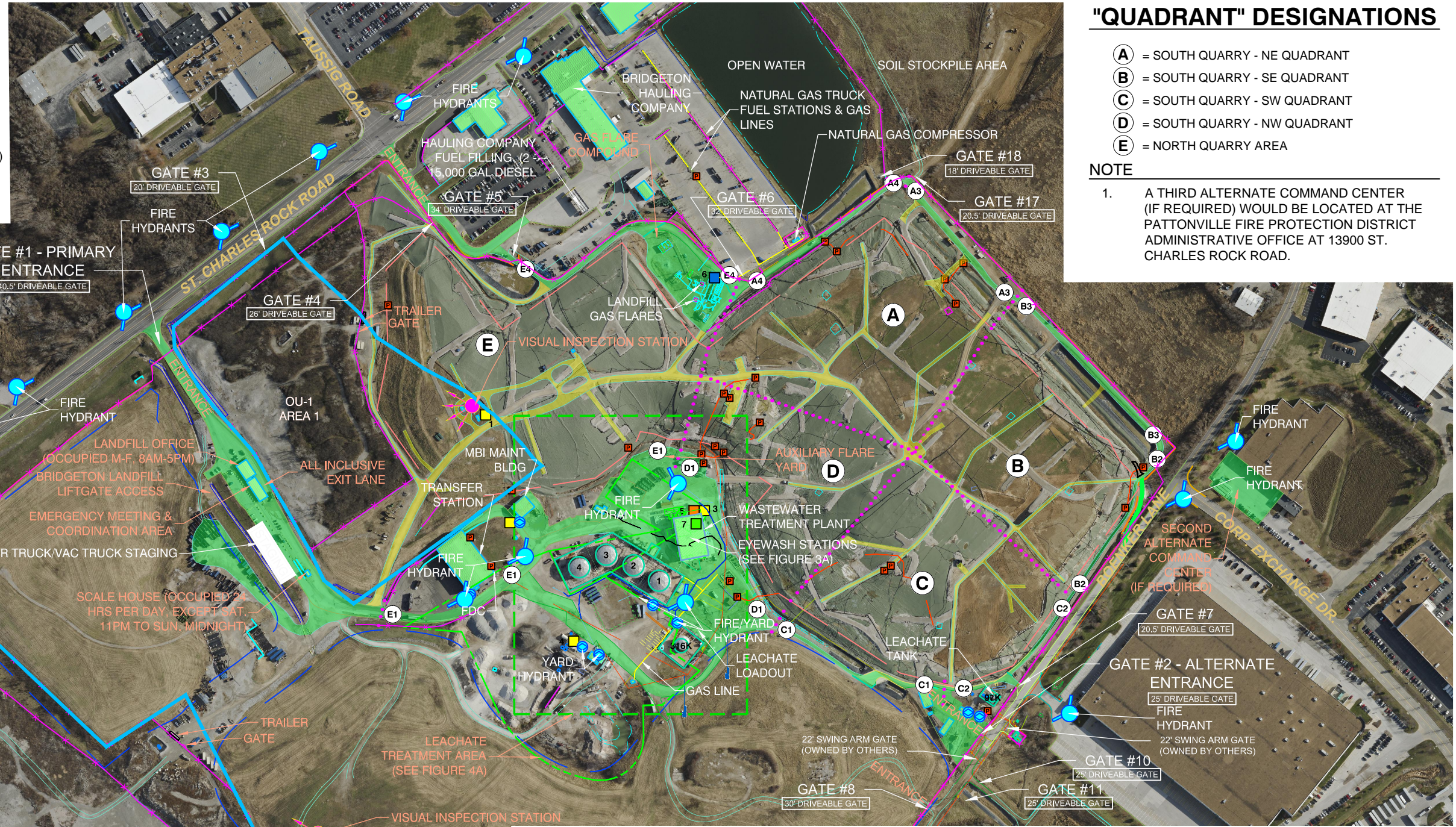

- (A) = SOUTH QUARRY - NE QUADRANT
- (B) = SOUTH QUARRY - SE QUADRANT
- (C) = SOUTH QUARRY - SW QUADRANT
- (D) = SOUTH QUARRY - NW QUADRANT
- (E) = NORTH QUARRY AREA

NOTE

- A THIRD ALTERNATE COMMAND CENTER (IF REQUIRED) WOULD BE LOCATED AT THE PATTONVILLE FIRE PROTECTION DISTRICT ADMINISTRATIVE OFFICE AT 13900 ST. CHARLES ROCK ROAD.

NOTES:

- AERIAL IMAGERY PROVIDED BY COOPER AERIAL SURVEYS, INC. AND IS DATED DECEMBER 12, 2018
- BASED ON FIGURES ORIGINALLY PREPARED BY CIVIL & ENVIRONMENTAL CONSULTANTS, INC. AND PRESENTED IN THE MARCH 28, 2019 INCIDENT MANAGEMENT PLAN.
- BACKGROUND INFORMATION REFLECTED FROM EMSI DRAWING DATED 2016



- - ON-SITE ALL-WEATHER ROADS AND STAGING AREAS ACCESSIBLE BY PUBLIC EMERGENCY RESPONSE
- - ON-SITE ALL-WEATHER ROADS ACCESSIBLE BY BRIDGETON LANDFILL EQUIPMENT
- - EXISTING YARD HYDRANT AND FIRE HYDRANT
- - NATURAL GAS LINE
- - ABOVEGROUND ELECTRIC LINE
- - FENCE LINE
- - POWER SUPPLY PANEL

PREPARED BY

Engineering for a Better World
FEEZOR
 ENGINEERING, INC.

3377 Hollenberg Dr, Bridgeton, MO 63044, Ph: 217-483-3118
 Missouri State Certificate Of Authority #: E-200912211

PROJECT	BRIDGETON/WEST LAKE LANDFILL INCIDENT MANAGEMENT PLAN (IMP) BRIDGETON, ST. LOUIS COUNTY, MO	PREPARED FOR	BRIDGETON/WEST LAKE LANDFILL 13570 ST. CHARLES ROCK ROAD BRIDGETON, MISSOURI 63044
DRAWING TITLE	FIGURE 3 FIRE HYDRANT LOCATIONS		
PROJECT NUMBER: BT-202	C:\Users\User\Dropbox (Feezor Engineering)\Bridgeton\BT-202 (Incident Management Plan)\2019\to Be Filed\figures 1-7\Fig 3_3A_4		



"QUADRANT" DESIGNATIONS

- (A) = SOUTH QUARRY - NE QUADRANT
- (B) = SOUTH QUARRY - SE QUADRANT
- (C) = SOUTH QUARRY - SW QUADRANT
- (D) = SOUTH QUARRY - NW QUADRANT
- (E) = NORTH QUARRY AREA

LEGEND

- EXISTING YARD HYDRANT AND FIRE HYDRANT
- ON-SITE ALL-WEATHER ROADS AND STAGING AREAS ACCESSIBLE BY PUBLIC EMERGENCY RESPONSE
- ON-SITE ALL-WEATHER ROADS ACCESSIBLE BY BRIDGETON LANDFILL EQUIPMENT
- FENCE LINE

NOTES:

- 1.) AERIAL IMAGERY PROVIDED BY COOPER AERIAL SURVEYS, INC. AND IS DATED DECEMBER 12, 2018
- 2.) BASED ON FIGURES ORIGINALLY PREPARED BY CIVIL & ENVIRONMENTAL CONSULTANTS, INC. AND PRESENTED IN THE MARCH 28, 2019 INCIDENT MANAGEMENT PLAN.
- 3.) BACKGROUND INFORMATION REFLECTED FROM EMSI DRAWING DATED 2016
- 4.) A THIRD ALTERNATE COMMAND CENTER (IF REQUIRED) WOULD BE LOCATED AT THE PATTONVILLE FIRE PROTECTION DISTRICT ADMINISTRATIVE OFFICE AT 13900 ST. CHARLES ROCK ROAD.



PREPARED BY



3377 Hollenberg Dr, Bridgeton, MO 63044, Ph: 217-483-3118
Missouri State Certificate Of Authority #: E-200912211

PROJECT

BRIDGETON/WEST LAKE LANDFILL
INCIDENT MANAGEMENT PLAN (IMP)
BRIDGETON, ST. LOUIS COUNTY, MO

DRAWING TITLE

**FIGURE 3A
EMERGENCY LOCATOR MAP**

PREPARED FOR

BRIDGETON/WEST LAKE LANDFILL
13570 ST. CHARLES ROCK ROAD
BRIDGETON, MISSOURI 63044

PROJECT NUMBER: BT-202

C:\Users\User\Dropbox (Feezor Engineering)\Bridgeton\BT-202 (Incident Management Plan)\2019\to Be Filed\figures 1-7\Fig 3_3A_4

LEACHATE TREATMENT AREA

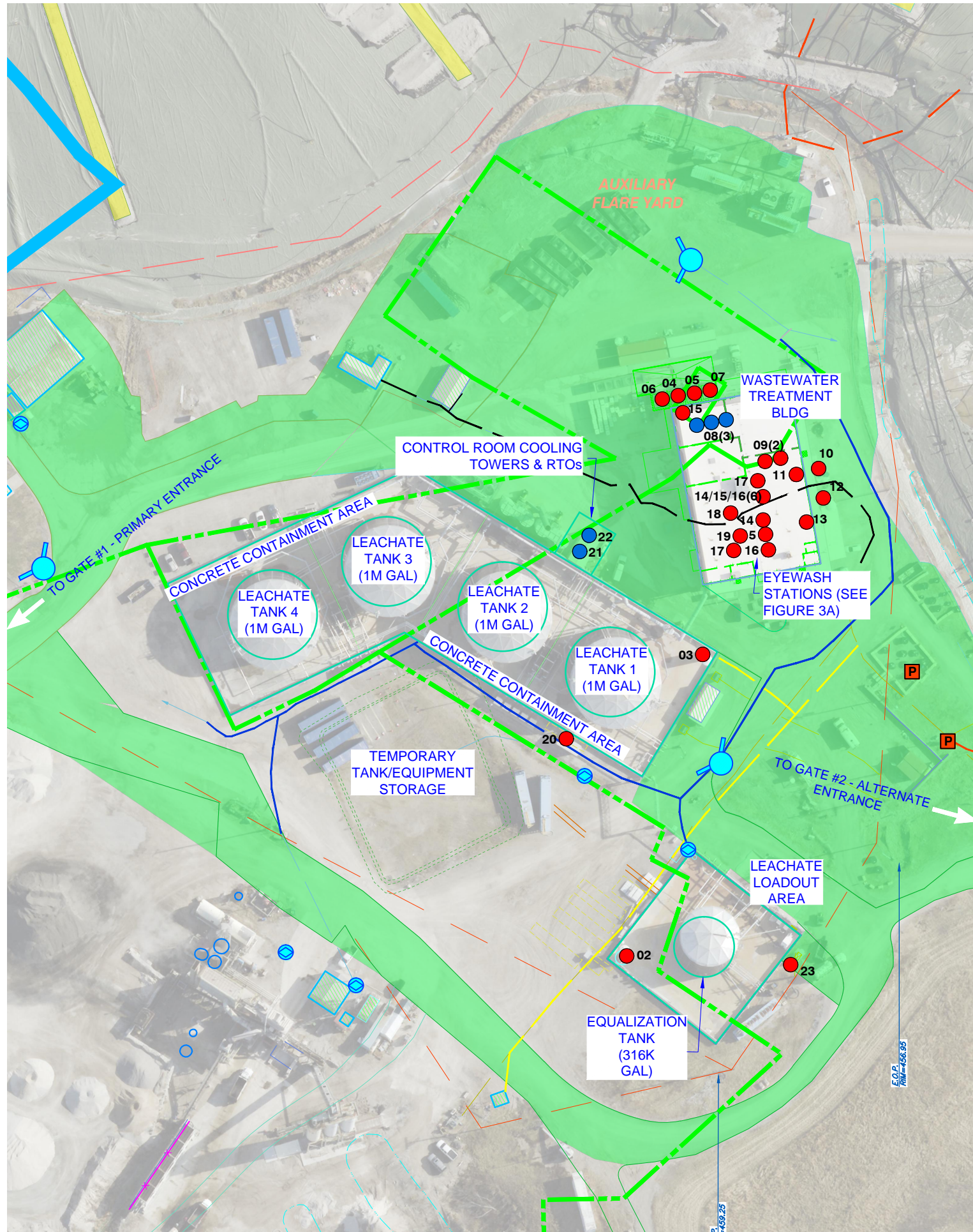

LEGEND

BULK STORAGE CONTAINERS

- 02 ● - IDLE - 6,000 GAL
- 03 ● - IDLE - 6,000 GAL
- 04 ● - SODIUM HYDROXIDE (CAUSTIC) - 6,000 GAL
- 05 ● - 50% SODIUM HYDROXIDE (CAUSTIC) - 6,000 GAL
- 06 ● - SODIUM NITRATE - 6,000 GAL
- 07 ● - ALUMINUM CHLOROHYDRATE - 6,000 GAL
- 08 ● - CITRIC ACID DRUM - 55 GAL
- 09 ● - ANTIFOAM TOTE - 270 GAL
- 10 ● - NAC03 SILO - 49 TONS
- 11 ● - NAC03 MIX TANK - 1,000 GAL
- 12 ● - CO2 STORAGE TANK - 50 TONS
- 13 ● - NACL MAKE-UP TANK - 1.9 TONS
- 14 ● - AMMONIUM NITRATE TOTE - 270 GAL
- 15 ● - ANTI-SCALANT TOTE - 270 GAL
- 16 ● - H3PO4 TOTE - 270 GAL

- 17 ● - CATIONIC POLYMER TOTE - 270 GAL
- 18 ● - SODIUM CHLORIDE SUPER SAC - 2000 LBS
- 19 ● - CATIONIC POLYMER STORAGE TANK - 850 GAL
- 20 ● - ANTIFOAM STORAGE TANK - 1,200 GAL
- 21 ● - BIOCID (BROMINE & SODIUM HYPOCHLORITE/HYDROXIDE) - 55 GAL
- 22 ● - CORROSION/SCALE INHIBITOR - 55 GAL
- 23 ● - HYDRITE 3120 SUPPRESSOR - 330 GAL

GENERAL LEGEND

- ON-SITE ALL-WEATHER ROADS AND STAGING AREAS ACCESSIBLE BY PUBLIC EMERGENCY RESPONSE
- ON-SITE ALL-WEATHER ROADS ACCESSIBLE BY BRIDGETON LANDFILL EQUIPMENT
- NATURAL GAS LINE
- ELECTRIC LINE
- FENCE LINE
- P POWER SUPPLY PANEL
- XX ● - 55 GALLON CONTAINER
- XX ● - BULK CONTAINER (>55 GAL)

KEY

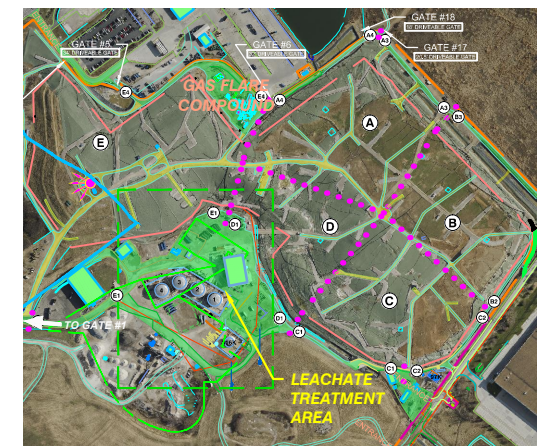

NOTES:

- 1.) AERIAL IMAGERY PROVIDED BY COOPER AERIAL SURVEYS, INC. AND IS DATED DECEMBER 12, 2018
- 2.) BASED ON FIGURES ORIGINALLY PREPARED BY CIVIL & ENVIRONMENTAL CONSULTANTS, INC. AND PRESENTED IN THE MARCH 28, 2019 INCIDENT MANAGEMENT PLAN.
- 3.) BACKGROUND INFORMATION REFLECTED FROM EMSI DRAWING DATED 2016
- 4.) A THIRD ALTERNATE COMMAND CENTER (IF REQUIRED) WOULD BE LOCATED AT THE PATTONVILLE FIRE PROTECTION DISTRICT ADMINISTRATIVE OFFICE AT 13900 ST. CHARLES ROCK ROAD.
- 5.) THE LEACHATE TREATMENT AREA DEPICTED DOES CONTAIN 100 LB PROPANE FUEL TANKS AND 500 GAL DIESEL FUEL TANKS (SEE FIGURE 3 FOR MORE DETAILS).

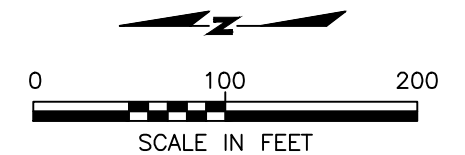

PREPARED BY



3377 Hollenberg Dr, Bridgeton, MO 63044, Ph: 217-483-3118
Missouri State Certificate Of Authority #: E-200912211

PROJECT

BRIDGETON/WEST LAKE LANDFILL
INCIDENT MANAGEMENT PLAN (IMP)
BRIDGETON, ST. LOUIS COUNTY, MO

PREPARED FOR

BRIDGETON/WEST LAKE LANDFILL
13570 ST. CHARLES ROCK ROAD
BRIDGETON, MISSOURI 63044

DRAWING TITLE

FIGURE 4
CHEMICAL STORAGE AREAS

PROJECT NUMBER: BT-202

C:\Users\User\Dropbox (Feezor Engineering)\Bridgeton\BT-202 (Incident Management Plan)\2019 to Be Filed\figures 1-7\Fig 3_3A_4



LEGEND

- - - NATIVE ROADS - TRACTOR & FIRE TRUCK PASSABLE
- - - NATIVE ROADS - FIRE TRUCK PASSABLE
- FIRE HYDRANT

NOTES:

- 1.) AERIAL IMAGERY PROVIDED BY COOPER AERIAL SURVEYS, INC. AND IS DATED DECEMBER 12, 2018
- 2.) BASED ON FIGURES ORIGINALLY PREPARED BY CIVIL & ENVIRONMENTAL CONSULTANTS, INC. AND PRESENTED IN THE MARCH 28, 2019 INCIDENT MANAGEMENT PLAN.

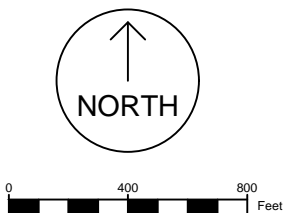

PREPARED BY

Engineering for a Better World
FEEZOR
ENGINEERING, INC.

3377 Hollenberg Dr, Bridgeton, MO 63044, Ph: 217-483-3118
Missouri State Certificate Of Authority #: E-200912211

PROJECT

BRIDGETON/WEST LAKE LANDFILL
INCIDENT MANAGEMENT PLAN (IMP)
BRIDGETON, ST. LOUIS COUNTY, MO

DRAWING TITLE

**FIGURE 5
EMERGENCY ACCESS ROAD PLAN
PROPOSED CONDITIONS**

PROJECT NUMBER: BT-202

PREPARED FOR

BRIDGETON/WEST LAKE LANDFILL
13570 ST. CHARLES ROCK ROAD
BRIDGETON, MISSOURI 63044

C:\Users\User\Dropbox (Feezor Engineering)\Bridgeton\BT-202 (Incident Management Plan)\2019\to Be Filed\figures 1-7\Fig 5_6_7

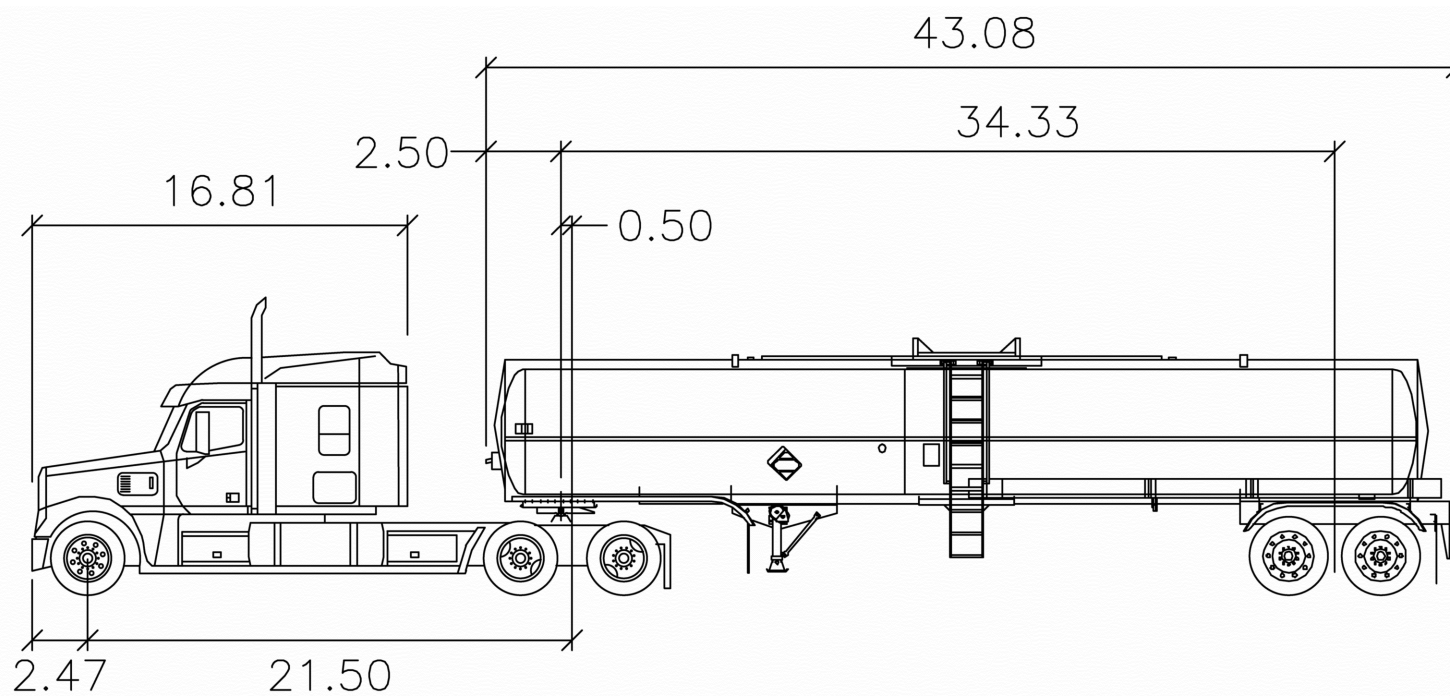

Brenner Tank Trailer

feet

Tractor Width	: 8.00	Lock to Lock Time	: 6.0
Trailer Width	: 8.00	Steering Angle	: 40.1
Tractor Track	: 8.00	Articulating Angle	: 70.0
Trailer Track	: 8.00		

BRENNER TANKER TRUCK

**TRACTOR: INTERNATIONAL TRUCK AND ENGINE CORPORATION
INTERNATIONAL 9900ix (JULY 16, 2008)**

TRAILER: BAKER CORP. BRENNER TANKER TRAILER (JUNE 9, 2008)

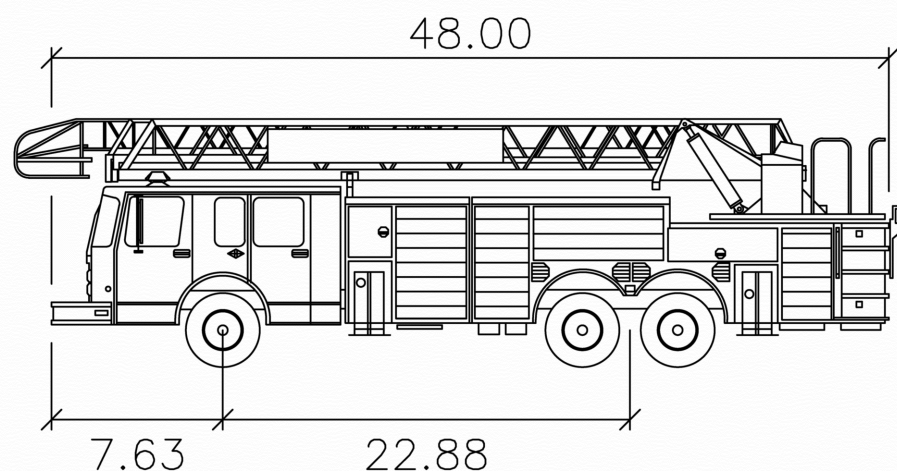

Pattonville—Fire Truck

feet

Width	: 8.50
Track	: 8.50
Lock to Lock Time	: 6.0
Steering Angle	: 33.3

PATTONVILLE FIRE DISTRICT - FIRE TRUCK

**PIERCE MANUFACTURING, INC. - 95FT. MIDMOUNT AERIAL
PLATFORM AND BODY ASSY (MMP95A) 300 GALLON WATER TANK**

NOTE:

- 1.) BASED ON FIGURES ORIGINALLY PREPARED BY CIVIL & ENVIRONMENTAL CONSULTANTS, INC. AND PRESENTED IN THE MARCH 28, 2019 INCIDENT MANAGEMENT PLAN.

PREPARED BY  Engineering for a Better World FEEZOR ENGINEERING, INC. 3377 Hollenberg Dr, Bridgeton, MO 63044, Ph: 217-483-3118 Missouri State Certificate Of Authority #: E-200912211	PROJECT BRIDGETON/WEST LAKE LANDFILL INCIDENT MANAGEMENT PLAN (IMP) BRIDGETON, ST. LOUIS COUNTY, MO	PREPARED FOR BRIDGETON/WEST LAKE LANDFILL 13570 ST. CHARLES ROCK ROAD BRIDGETON, MISSOURI 63044
	DRAWING TITLE <h2 style="text-align: center;">FIGURE 6</h2> <h3 style="text-align: center;">EMERGENCY ACCESS ROAD PLAN TRUCK SCHEMATICS</h3>	
PROJECT NUMBER: BT-202		<small>C:\Users\plins\Dropbox (Feezor Engineering)\Bridgeton\BT-202 (Incident Management Plan)\2019\to Be Filed\figures Edit 10-31-2019\Fig 5 6 7</small>



LEGEND

● KGXX KNIFE GATE VALVE

NOTES:

- 1.) AERIAL IMAGERY PROVIDED BY COOPER AERIAL SURVEYS, INC. AND IS DATED DECEMBER 12, 2018
- 2.) BASED ON FIGURES ORIGINALLY PREPARED BY CIVIL & ENVIRONMENTAL CONSULTANTS, INC. AND PRESENTED IN THE MARCH 28, 2019 INCIDENT MANAGEMENT PLAN.

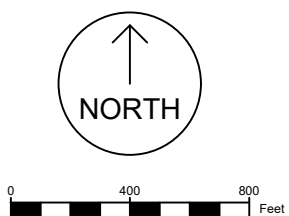

PREPARED BY

Engineering for a Better World
FEEZOR
 ENGINEERING, INC.

3377 Hollenberg Dr, Bridgeton, MO 63044, Ph: 217-483-3118
 Missouri State Certificate Of Authority #: E-200912211

PROJECT

BRIDGETON/WEST LAKE LANDFILL
 INCIDENT MANAGEMENT PLAN (IMP)
 BRIDGETON, ST. LOUIS COUNTY, MO

PREPARED FOR

BRIDGETON/WEST LAKE LANDFILL
 13570 ST. CHARLES ROCK ROAD
 BRIDGETON, MISSOURI 63044

DRAWING TITLE

**FIGURE 7
 KNIFE GATE VALVE LOCATION MAP**

APPENDIX A
RESPONSE AND INCIDENT STRATEGIES FOR POTENTIAL INCIDENTS

INCIDENT – BRIDGETON LANDFILL - SURFACE FIRE

INITIAL ASSESSMENT BY FACILITY EMERGENCY COORDINATOR

Level 0

- Small affected area, or
- Minor smoke plume, and
- Equipment and personnel on-site sufficient to resolve incident.

RESPONSE

1. Notify on-site personnel
2. Call and notify Facility Emergency Coordinator
3. Notify MDNR WMP, MDHSS, St. Louis Co. DoH, and EPA R7
4. Notify Pattonville FD On-Duty Battalion Chief and Assistant Fire Chief
5. Notify Robertson FD Assistant Fire Chief
6. Notify Bridgeton PD
7. Coordinate extinguishment (with extinguishers or water truck spray)
8. Implement measures to control run-on and run-off from any areas where water is applied
9. Monitor continuously for one hour to ensure fire has been extinguished
10. Perform odor assessment in accordance with Bridgeton Landfill Odor Management Plan
11. Assess potential damage to systems and make repairs

CONTACT INFORMATION

Pattonville FD

- On-Duty Battalion Chief: 314-393-4802
- Assistant Fire Chief: 314-393-4807

Robertson FD

- Assistant Fire Chief: 314-575-5011

Bridgeton PD

- Chief Hood: 314-420-9112
- Major Mossotti: 314-602-3632

MDNR WMP

- Chris Nagel cell: 573-750-5401 or
- Mike Parris cell: 573-680-6669

MDHSS

- Keith Henke: 573-645-8943

St. Louis Co. DoH

- Mark Milward cell: 314-520-1373

EPA Region 7

- Tom Mahler cell: 816-604-0546

Level 1

- After normal business hours, or
- Insufficient on-site resources, or
- Flame/smoke visible from off-site, or
- Large affected area

RESPONSE

1. Notify on-site personnel
2. Call 9-1-1
3. Call and notify Facility Emergency Coordinator
4. Call Pattonville FD On-Duty Battalion Chief and Assistant Fire Chief
5. Call Robertson FD Assistant Fire Chief
6. Call Bridgeton PD
7. Notify MDNR WMP, MDHSS, St. Louis Co. DoH, and EPA R7
8. Suspend impacted, non-critical operations (unless such operation minimizes incident)
9. Coordinate extinguishment with Incident Commander
10. Implement measures to control run-on and run-off from any areas where water is applied
11. Monitor continuously for 48 hours to assure extinguishment
12. Perform odor assessment in accordance with Bridgeton Landfill Odor Management Plan
13. Assess potential damage to systems and make repairs
14. Resume regular operations with consent of Incident Commander

CONTACT INFORMATION

Emergency Dispatch

- 9-1-1 Dispatcher: 9-1-1

Pattonville FD

- On-Duty Battalion Chief: 314-393-4802
- Assistant Fire Chief: 314-393-4807

Robertson FD

- Assistant Fire Chief: 314-575-5011

Bridgeton PD

- Chief Hood: 314-420-9112
- Major Mossotti: 314-602-3632

MDNR WMP

- Chris Nagel cell: 573-750-5401 or
- Mike Parris cell: 573-680-6669

MDHSS

- Keith Henke: 573-645-8943

St. Louis Co. DoH

- Mark Milward cell: 314-520-1373

St. Louis Co. OEM

- Michele Ryan: 314-615-9508
- 24/7 Emergency: 314-615-5360

EPA Region 7

- Tom Mahler cell: 816-604-0546

INCIDENT – BRIDGETON LANDFILL - PERSONAL INJURY / MAN DOWN / PERSONNEL CONTAMINATION

**INITIAL ASSESSMENT
BY FACILITY EMERGENCY COORDINATOR**

Level 0
• Injury handled with on-site first aid

RESPONSE

1. Call and notify Facility Emergency Coordinator
2. No follow-up is required with first responders or regulatory agencies

Level 1
• Injury requiring first responder or paramedic assistance

RESPONSE

1. Call 9-1-1
2. Follow 9-1-1 operator instructions until first responders arrive
3. Call and notify Facility Emergency Coordinator
4. Brief first responders and/or Incident Commander upon arrival — follow instructions

CONTACT INFORMATION

Emergency Dispatch
• 9-1-1 Dispatcher: 9-1-1

INCIDENT – BRIDGETON LANDFILL - SUDDEN WASTE MOVEMENT / EXPOSED WASTE

INITIAL ASSESSMENT BY FACILITY EMERGENCY COORDINATOR

- Level 0
- Movement within limits of temporary cap or
 - Little or no exposed waste, and
 - Minor odor release

RESPONSE

1. Call and notify Facility Emergency Coordinator
2. Place soil at the toe of any areas where waste movement occurs in order to stabilize the area(s)
3. Turn off gas extraction wells within 200 feet of area of concern
4. Lightly cover tension cracks with clean, clayey soil
5. Notify MDNR WMP, MDHSS, St. Louis Co. DoH, and EPA R7
6. Notify Pattonville FD On-duty Battalion Chief and Assistant Fire Chief
7. Notify Robertson FD Assistant Fire Chief
8. Notify Bridgeton PD
9. Inspect infrastructure for any damage, leaks or failures
10. Implement measures to control run-on and run-off from any areas where waste materials are exposed
11. Perform odor assessment in accordance with Bridgeton Landfill Odor Management Plan
12. Monitor for one week; if no further movement, implement relocation of waste material and restoration

CONTACT INFORMATION

- Pattonville FD
- On-Duty Battalion Chief: 314-393-4802
 - Assistant Fire Chief: 314-393-4807
- Robertson FD
- Assistant Fire Chief: 314-575-5011
- Bridgeton PD
- Chief Hood: 314-420-9112
 - Major Mossotti: 314-602-3632

- MDNR WMP
- Chris Nagel cell: 573-750-5401 or
 - Mike Parris cell: 573-680-6669
- MDHSS
- Keith Henke: 573-645-8943
- St. Louis Co. DoH
- Mark Milward cell: 314-520-1373
- EPA Region 7
- Tom Mahler cell: 816-604-0546

- Level 1
- Massive movement, slope failure, erosion, flooding, tornado or other event that exposes waste material
 - Large exposure of waste material or
 - Hot (steaming) or burning waste exposed
 - Extensive release of gas and/or odors

RESPONSE

1. Notify on-site personnel
2. Call 9-1-1
3. Call and notify Facility Emergency Coordinator
4. Turn off gas extraction wells within 500 feet of area of concern
5. Call Pattonville FD On-Duty Battalion Chief and Assistant Fire Chief
6. Call Robertson FD Assistant Fire Chief
7. Call Bridgeton PD
8. Call EPA R7 Spill Line
9. Notify MDNR WMP, MDHSS, St. Louis Co. DoH, and EPA R7
10. Place soil at the toe of any areas where waste movement occurs in order to stabilize the area(s)
11. Implement measures to control run-on and run-off from any areas where waste materials are exposed
12. Lightly cover exposed waste with clean, clayey soil while buttressing toe at direction of professional engineer
13. Perform odor assessment in accordance with Bridgeton Landfill Odor Management Plan
14. Monitor for one month; if no further movement, implement relocation of waste material and restoration

CONTACT INFORMATION

- Emergency Dispatch
- 9-1-1 Dispatcher: 9-1-1
- Pattonville FD
- On-Duty Battalion Chief: 314-393-4802
 - Assistant Fire Chief: 314-393-4807
- Robertson FD
- Assistant Fire Chief: 314-575-5011
- Bridgeton PD
- Chief Hood: 314-420-9112
 - Major Mossotti: 314-602-3632

- MDNR WMP
- Chris Nagel cell: 573-750-5401 or
 - Mike Parris cell: 573-680-6669
- MDHSS
- Keith Henke: 573-645-8943
- St. Louis Co. DoH
- Mark Milward cell: 314-520-1373
- St. Louis Co. OEM
- Michele Ryan: 314-615-9508
- EPA Region 7
- 24/7 Emergency: 314-615-5360
 - Tom Mahler cell: 816-604-0546
- EPA R7 Spill Line: 913-281-0991

INCIDENT – BRIDGETON LANDFILL - LEACHATE RELEASE

INITIAL ASSESSMENT BY FACILITY EMERGENCY COORDINATOR

Level 0

- Event duration less than one hour and no visible off-site emissions and
- Leachate is contained to surface of landfill

RESPONSE

1. Call and notify Facility Emergency Coordinator
2. Verify storm water knife gates are shut
3. Create berm on landfill to capture liquid
4. Arrest release with temporary well cap or new wellhead
5. Inspect infrastructure for any damage, leaks or failures
6. Note event in site records

Level 1

- Event duration greater than one hour or
- Emissions visible from off-site or
- Leachate reaches beyond on-site surface water management features

RESPONSE

1. Notify on-site personnel
2. Call 9-1-1
3. Call and notify Facility Emergency Coordinator
4. Verify stormwater knife gates are shut and contain liquids in retention basin to extent possible
5. Arrest release
6. Call MDNR Spill Line and EPA R7 Spill Line
7. Call St. Louis Co. OEM / LEPC
8. Notify MDNR WMP, MDHSS, St. Louis Co. DoH, and EPA R7
9. Call Pattonville FD On-duty Battalion Chief and Assistant Fire Chief
10. Call Robertson FD Assistant Fire Chief
11. Call Bridgeton PD
12. Inspect infrastructure for any damage, leaks or failures
13. Perform odor assessment in accordance with Bridgeton Landfill Odor Management Plan
14. Note event in site records and report to MDNR and EPA in regular written report

CONTACT INFORMATION

Emergency Dispatch

- 9-1-1 Dispatcher: 9-1-1

Pattonville FD

- On-Duty Battalion Chief: 314-393-4802
- Assistant Fire Chief: 314-393-4807

Robertson FD

- Assistant Fire Chief: 314-575-5011

Bridgeton PD

- Chief Hood: 314-420-9112
- Major Mossotti: 314-602-3632

St. Louis Co. OEM

- Mark Diedrich cell: 314-615-6500
- 24/7 Emergency: 314-615-5360

MDNR WMP

- Chris Nagel cell: 573-750-5401 or
- Mike Parris cell: 573-680-6669

MDNR Spill Line (After Hours): 573-634-2436

MDHSS

- Keith Henke: 573-645-8943

St. Louis Co. DoH

- Mark Milward cell: 314-520-1373

St. Louis Co. OEM

- Michele Ryan: 314-615-9508
- 24/7 Emergency: 314-615-5360

EPA Region 7

- Tom Mahler cell: 816-604-0546
- EPA R7 Spill Line: 913-281-0991

APPENDIX B
FACILITY EMERGENCY COORIDNATOR CHECKLIST /
EMERGENCY RESPONDER COMMUNICATION

**Bridgeton Landfill and West Lake Landfill
Incident Management Plan (IMP)**

**FACILITY EMERGENCY COORDINATOR CHECKLIST /
EMERGENCY RESPONDER COMMUNICATION**

- a. Make initial classification and categorize incident.
- b. Initiate proper response strategy (Section 5). For notifications, collect the following information and communicate it to notified parties:
 - Location of the incident (by Quadrant)
 - Gate location closest to the incident
 - Incident Type and Level (0 or 1)
- c. Account for facility personnel.
- d. Assure appropriate access gates are open.
- e. Determine if environmental release is occurring and contain.
- f. Restore and resume normal operation.

INCIDENT DETAIL

Date and Time of Incident: _____

Facility Coordinator: _____

Description of Incident: _____

Date and Time Resume Normal Activity: _____

APPENDIX C
SPILL PREVENTION AND RESPONSE FOR LEACHATE

Spill Prevention and Response for Leachate

Spill Prevention

Leachate is collected from collection wells sumps throughout the landfill. The leachate is piped to collection tanks either directly or via internal lift stations. There are currently 4 lift stations. Under normal operations, leachate is pumped to Tank 200, (the 316K gallon equalization tank) mixed and aerated and then transferred to the pre-treatment plant for treatment. Aeration Tank 307A can also be used as an equalization tank if Tank 200 is not used. Treated or partially treated leachate can be transferred to hauling trucks at the leachate load-out station if necessary. Table 1 lists the devices and practices in place to prevent spills of leachate.

Table 1: Spill Prevention Devices and Practices

Spill Prevention Devices and Practices	Tank 600	Tank 200 and Tanks 307A-D	Frac Tanks	Pumps and Lift Stations	Leachate Piping	Truck Load-out Station
SCADA level sensor	*	*		*	NA	NA
Minimum freeboard	*	*	*	*	NA	NA
High level alarm light	*	*		*	NA	NA
Overfill prevention feed shutoffs		*		*		
Bypass valves				*		
Secondary tank containment	*	*	*	*	NA	*
Underground dual containment piping	*	*	*	*	*	*
Pumps turned off during maintenance	*	*	*	*	*	*
Dry disconnect couplings	NA	NA	*	NA	*	
Drip pans			*		*	
Vac Truck available to clean containment	*	*	*	*	*	*
Daily inspection	*	*	*	*	*	* ¹

¹ Loading is monitored continuously by driver

Leachate Piping

- All leachate conveyance piping is dual containment with the exception of the pressurized well manifolds. This piping lies entirely on top of the flexible membrane line and is connected to dual containment sumps. Single walled piping may be used in temporary applications when necessary.
- There are no hose flanges or connections in piping. The only connections are at pumps, valves, and tanks, all of which have containment systems.
- During maintenance involving pipe disconnection, pipes are vacuumed with a vac truck as needed to avoid spillage: there are two vac trucks on site.

- Drip pans are used as needed during pipe disconnection while performing maintenance.

Leachate Pumps and Lift Station

- Each lift station is equipped with a high level alarm that activates a second pump to reduce volume quickly. If necessary, a second high-high level alarm triggers an automatic by-pass of the lift station and sends leachate directly to Tank 200.
- The lift stations and LCSs are equipped with SCADA monitoring and controls.
- Pumps and valve connections are within dual containment vaults.
- During maintenance, affected pumps are shut off and/or squeeze-off tools/valves are used to redirect leachate.
- After maintenance, leachate is removed from vaults and containments with a vacuum truck.

Tank 200 and Tanks 307A-D

- Tanks are in secondary containment systems capable of holding 110% of the capacity of the tank.
- Tank filling is conducted automatically and controlled from overflowing by level instruments connected to the SCADA system with high and high-high level alarms which turn off flow to the tanks and is also monitored by on-site staff, 24 hours per day, 7 days per week.
- Tank levels are monitored via SCADA equipment and on local digital readout.
- There is a 22' maximum fill height in Tank 200, when this level is exceeded the SCADA system displays a high level alarm on the computer screen.
- The SCADA system generates a phone text and/or email message to designated users when the high level point is reached.
- There is a local high level alarm light on the SCADA panel at the tank.
- All tanks and containments are inspected daily, the staff is on site 24 hours per day, 7 days per week.

Tank 600

- The tank has a secondary containment system capable of holding 110% of the capacity of the tank.
- There is an overflow bypass system to the secondary containment with a sump to the MSD lift station.
- Tank filling is conducted automatically and controlled from overflowing by level instruments connected to the SCADA system with high and high-high level alarms which turn off flow to the tank and is also monitored by on-site staff, 24 hours per day, 7 days per week.
- Tanks are monitored via SCADA equipment and on local digital readout.
- There is a 29'1" maximum fill height; when the freeboard is exceeded the SCADA system displays a high level on-screen alarm.
- The SCADA system generates a phone text and/or email message to designated users when the high level point is reached.
- There is a local high level alarm light on the SCADA panel at the tank.

- All tanks and containments are inspected daily, the staff is on site 24 hours per day, 7 days per week.

Truck Load-out Station

- The load-out station has a concrete containment.
- The containment drains to a sump which pumps the liquid into Tank 200.
- Truck loading is monitored continuously by the truck driver in an overhead safety cage; engineering controls prevent the driver from leaving the area during filling.

Frac Tanks

- Each frac tank has an isolation/shut off valve.
- Each frac tank has a polyethylene containment system and on-site vac trucks are available to enable quick response to remove any spills.
- During piping changes or maintenance, pipes are vacuumed empty with a vac truck to avoid spillage.

APPENDIX D
ON-SITE FIRE HYDRANT FLOW TEST REPORTS

WATER FLOW TEST REPORT



359 Shockdrake Court Wentzville, MO 63385 Phone 636-332-9578 Email tonyh@hfsdesign.net

Residual Hydrant Readings	
Static pressure (psi)	140
Residual pressure (psi)	62

Flow Hydrant 1	
Pitot pressure (psi)	58
Outlet diameter (in.)	2 1/2
Outlet coefficient	0.9
Pumper coefficient	1
Adjusted coefficient	0.9
Flow (gpm)	1278.308

Flow Hydrant 2	
Pitot pressure (psi)	0
Outlet diameter (in.)	2 1/2
Outlet coefficient	0.9
Pumper coefficient	1
Adjusted coefficient	0.9
Flow (gpm)	0

Total Flow (gpm)	1278.308
------------------	----------

Minimum desired pressure (psi):	20
Expected flow at min. pressure (gpm):	1613.103

Minimum desired flow (gpm):	1500
Expected pressure at min. flow (psi):	35.11421

Expected flow at 0 psi:	1753.127
-------------------------	----------

Pumper Outlet Coefficients (NFPA 291 Table 4.8.2)	
Pitot reading (psi)	Coefficient
2	0.97
3	0.92
4	0.89
5	0.86
6	0.84
7+	0.83

Project Name: Bridgeton Landfill
 Project Address: 13570 St. Charles Rock Road
 Bridgeton, MO 63044

Flow Test No.: 1 of 4
 Date and Time: Wednesday August 9, 2017 at 8:00 a.m.
 Performed by: HFS Design
 Map provided: Yes

Notes: Fire hydrant #3 was gauged and fire hydrant #4 was flowed.

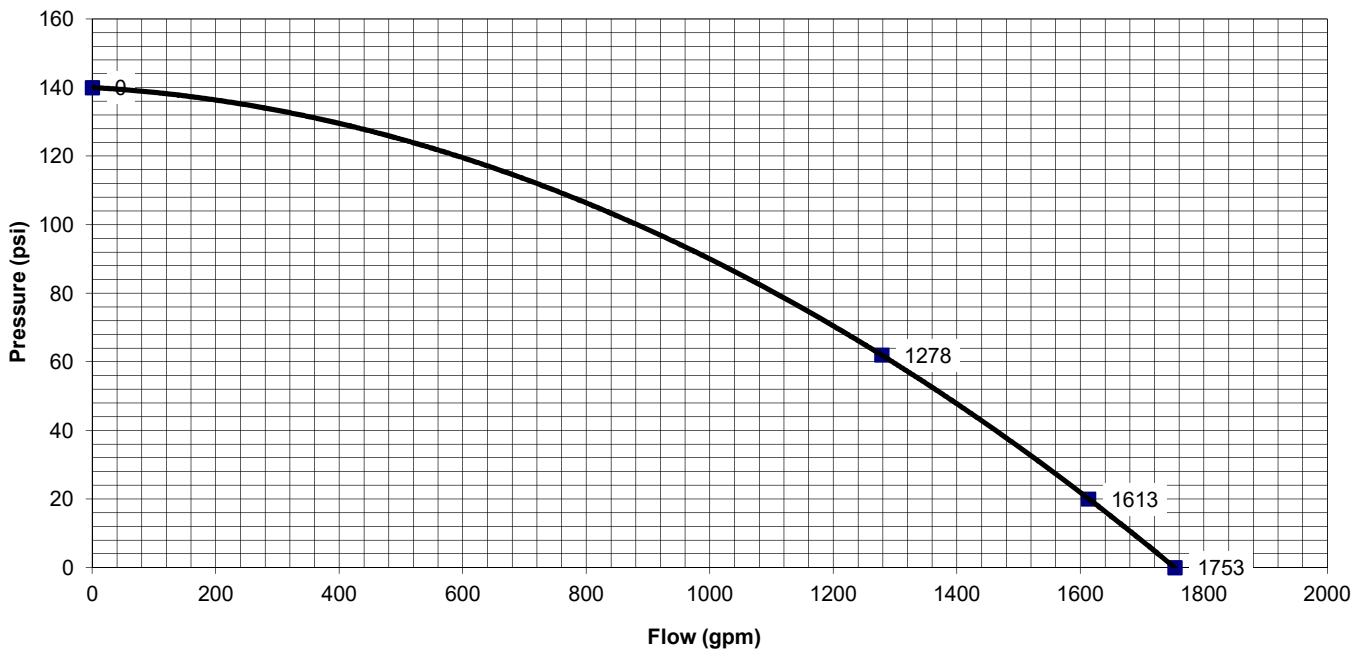

WATER FLOW TEST REPORT



359 Shockdrake Court Wentzville, MO 63385 Phone 636-332-9578 Email tonyh@hfsdesign.net

Residual Hydrant Readings	
Static pressure (psi)	140
Residual pressure (psi)	116

Flow Hydrant 1	
Pitot pressure (psi)	43
Outlet diameter (in.)	2 1/2
Outlet coefficient	0.9
Pumper coefficient	1
Adjusted coefficient	0.9
Flow (gpm)	1100.666

Flow Hydrant 2	
Pitot pressure (psi)	0
Outlet diameter (in.)	2 1/2
Outlet coefficient	0.9
Pumper coefficient	1
Adjusted coefficient	0.9
Flow (gpm)	0

Total Flow (gpm)	1100.666
------------------	----------

Minimum desired pressure (psi):	20
Expected flow at min. pressure (gpm):	2624.819

Minimum desired flow (gpm):	1500
Expected pressure at min. flow (psi):	97.42387

Expected flow at 0 psi:	2852.664
-------------------------	----------

Pumper Outlet Coefficients (NFPA 291 Table 4.8.2)	
Pitot reading (psi)	Coefficient
2	0.97
3	0.92
4	0.89
5	0.86
6	0.84
7+	0.83

Project Name: Bridgeton Landfill
 Project Address: 13570 St. Charles Rock Road
 Bridgeton, MO 63044

Flow Test No.: 2 of 4
 Date and Time: Wednesday August 9, 2017 at 8:15 a.m.
 Performed by: HFS Design
 Map provided: Yes

Notes: Fire hydrant #2 was gauged and fire hydrant #3 was flowed.

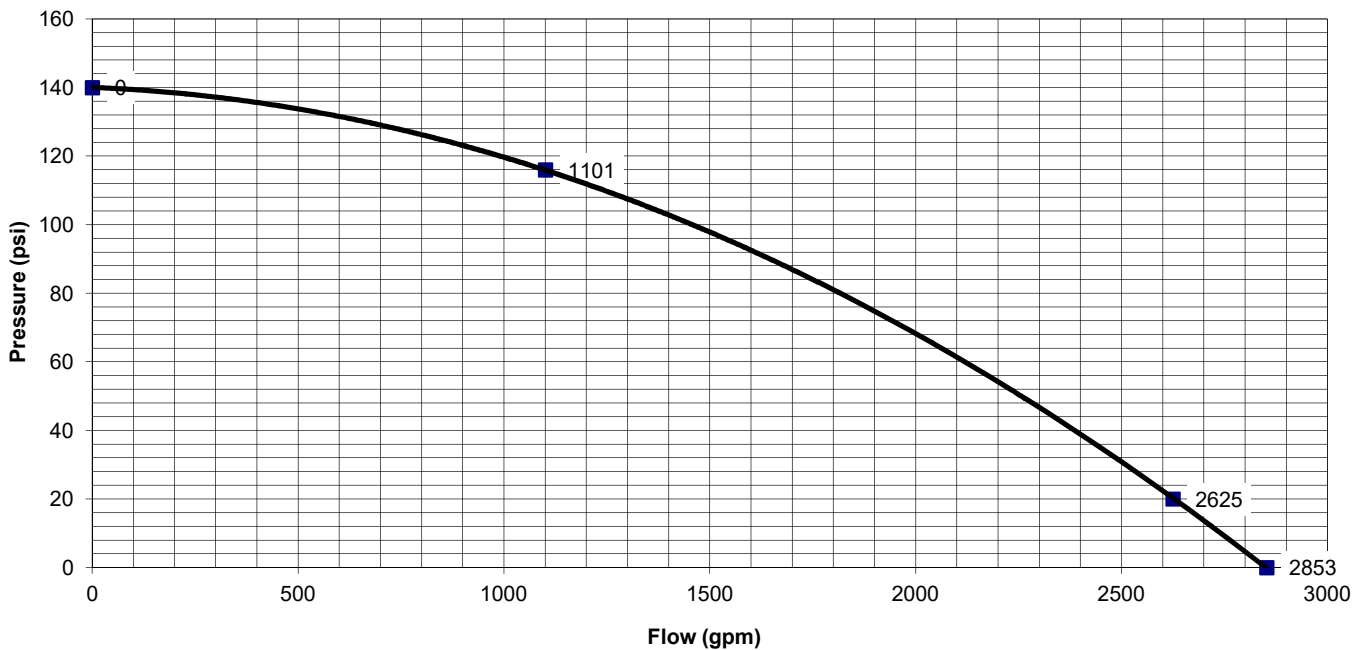

WATER FLOW TEST REPORT



359 Shockdrake Court Wentzville, MO 63385 Phone 636-332-9578 Email tonyh@hfsdesign.net

Residual Hydrant Readings	
Static pressure (psi)	140
Residual pressure (psi)	102

Flow Hydrant 1	
Pitot pressure (psi)	85
Outlet diameter (in.)	2 1/2
Outlet coefficient	0.9
Pumper coefficient	1
Adjusted coefficient	0.9
Flow (gpm)	1547.501

Flow Hydrant 2	
Pitot pressure (psi)	0
Outlet diameter (in.)	2 1/2
Outlet coefficient	0.9
Pumper coefficient	1
Adjusted coefficient	0.9
Flow (gpm)	0

Total Flow (gpm)	1547.501
------------------	----------

Minimum desired pressure (psi):	20
Expected flow at min. pressure (gpm):	2879.423

Minimum desired flow (gpm):	1500
Expected pressure at min. flow (psi):	104.1317

Expected flow at 0 psi:	3129.369
-------------------------	----------

Pumper Outlet Coefficients (NFPA 291 Table 4.8.2)	
Pitot reading (psi)	Coefficient
2	0.97
3	0.92
4	0.89
5	0.86
6	0.84
7+	0.83

Project Name: Bridgeton Landfill
 Project Address: 13570 St. Charles Rock Road
 Bridgeton, MO 63044

Flow Test No.: 3 of 4
 Date and Time: Wednesday August 9, 2017 at 8:30 a.m.
 Performed by: HFS Design
 Map provided: Yes

Notes: Fire hydrant #1 was gauged and fire hydrant #2 was flowed.

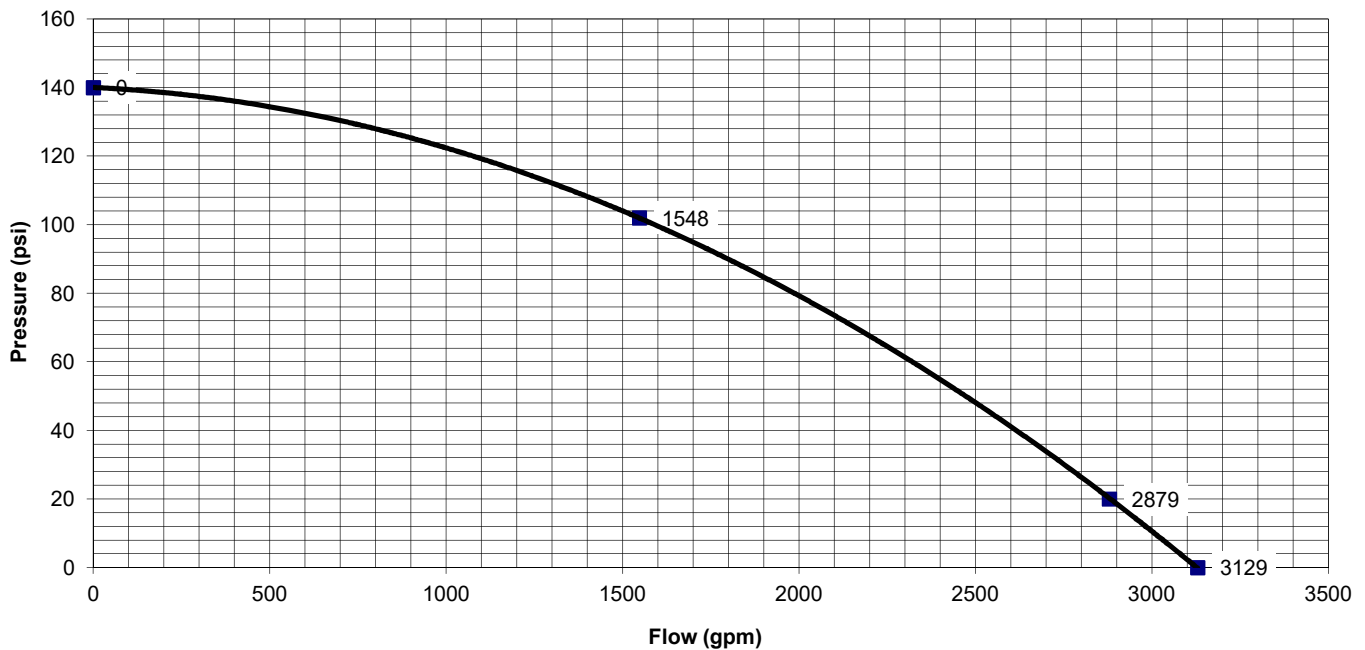

WATER FLOW TEST REPORT



359 Shockdrake Court Wentzville, MO 63385 Phone 636-332-9578 Email tonyh@hfsdesign.net

Residual Hydrant Readings	
Static pressure (psi)	140
Residual pressure (psi)	97

Flow Hydrant 1	
Pitot pressure (psi)	82
Outlet diameter (in.)	2 1/2
Outlet coefficient	0.9
Pumper coefficient	1
Adjusted coefficient	0.9
Flow (gpm)	1519.946

Flow Hydrant 2	
Pitot pressure (psi)	0
Outlet diameter (in.)	2 1/2
Outlet coefficient	0.9
Pumper coefficient	1
Adjusted coefficient	0.9
Flow (gpm)	0

Total Flow (gpm)	1519.946
------------------	----------

Minimum desired pressure (psi):	20
Expected flow at min. pressure (gpm):	2645.533

Minimum desired flow (gpm):	1500
Expected pressure at min. flow (psi):	98.03914

Expected flow at 0 psi:	2875.176
-------------------------	----------

Pumper Outlet Coefficients (NFPA 291 Table 4.8.2)	
Pitot reading (psi)	Coefficient
2	0.97
3	0.92
4	0.89
5	0.86
6	0.84
7+	0.83

Project Name: Bridgeton Landfill
 Project Address: 13570 St. Charles Rock Road
 Bridgeton, MO 63044

Flow Test No.: 4 of 4
 Date and Time: Wednesday August 9, 2017 at 8:45 a.m.
 Performed by: HFS Design
 Map provided: Yes

Notes: Fire hydrant #4 was gauged and fire hydrant #1 was flowed.

