



LANDFILL GAS CORRECTIVE ACTION UPDATE

BRIDGETON LANDFILL

BRIDGETON, ST. LOUIS COUNTY, MISSOURI

Submitted Pursuant to Section 23 of Agreed Order
Case No. 13SL-CC01088, Effective May 13, 2013

Prepared For:
Bridgeton Landfill, LLC
13570 St. Charles Rock Road
Bridgeton, MO 63044

January, 15 2021

Project No.: BT-133

Prepared By:

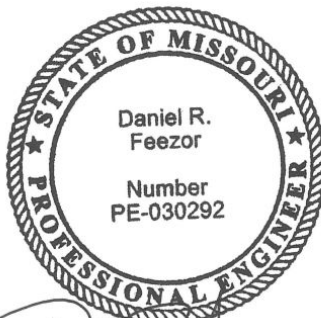

Feezor Engineering, Inc.
3377 Hollenberg Drive
Bridgeton, MO 63044

TABLE OF CONTENTS

1.0	INTRODUCTION	1
2.0	REVIEW OF CURRENT GAS MIGRATION CONTROL STATUS	2
3.0	RECENT GAS MIGRATION CONTROL EFFORTS	4
4.0	PROPOSED AND ONGOING GAS MIGRATION CONTROL EFFORTS	6
5.0	CONTINUED MONITORING AND REPORTING	8

TAB LES

Table 1:	List of Landfill Gas Monitoring Probes	
Table 2:	Compliance Gas Monitoring Probe Data	(10/01/20 – 12/31/20)
Table 3:	Sentry Gas Monitoring Probe Data	(10/01/20 – 12/31/20)
Table 4:	Investigative Gas Monitoring Probe Data	(10/01/20 – 12/31/20)
Table 5:	Public Safety Gas Monitoring Probe Data	(10/01/20 – 12/31/20)
Table 6:	Gas Monitoring Probe Water Level Data	(10/01/20 – 12/31/20)
Table 7:	Temporary Monitoring Point Data	(10/01/20 – 12/31/20)
Table 8:	Temporary Monitoring Point Water Level Data	(10/01/20 – 12/31/20)

APPENDICES

Appendix A:	Text of Landfill Gas Corrective Action Plan Update	(7/26/2013)
Appendix B:	Gas Monitoring Probe Methane Level Graphs	(12/31/2019 – 12/31/2020)
Appendix C:	Infrastructure Site Plan, Gas Monitoring Probes	
Appendix D:	2020 GCCS Improvements	
Appendix E:	As-Built Boring Locations – Drawing 003 (from geoprobe as-built report)	

1.0 INTRODUCTION

On May 13, 2013, Bridgeton Landfill (BL), LLC entered into an Agreed Order with the State of Missouri which required actions to address a subsurface reaction (SSR) occurring in the South Quarry area of the Bridgeton Landfill (BL). Section 23 of the Agreed Order required the preparation of an updated “Landfill Gas Corrective Action Plan” (CAP) and requested that the update consider SSR control measures. Bridgeton Landfill, LLC subsequently submitted an updated CAP on July 26, 2013. On June 29, 2018, Bridgeton Landfill LLC entered into the Final Consent Judgment (Case No. 13SL-CC01088-01) between Bridgeton Landfill, LLC and the State of Missouri). Paragraph 39 of the Final Consent Judgement requires the continuation of the quarterly CAP updates.

Section 5.0 of the July 2013 CAP proposed that weekly monitoring data would be summarized and reviewed in a quarterly report to be submitted on the 15th day of the month following each quarter. The Missouri Department of Natural Resources (MDNR) accepted this proposal in a letter dated October 18, 2013. Bridgeton Landfill, LLC has subsequently submitted updated Quarterly Corrective Action Plan Updates each quarter. The purpose of this document is to provide monitoring data for the fourth quarter of 2020 (October 01, 2020 – December 31, 2020) and to review the current status of gas migration control measures.

The text of the July 2013 CAP is presented in **Appendix A** for reference.

2.0 REVIEW OF CURRENT GAS MIGRATION CONTROL STATUS

The BL continues an aggressive monitoring program and significant infrastructure investment with respect to landfill gas migration control at the facility.

Detailed graphs showing approximately one year of methane concentrations as measured in the probes December 31, 2019 to December 31, 2020 are included in this document as **Appendix B**.

Table 1 lists the gas monitoring probes and their corresponding abbreviations, as presented in the July 2013 CAP, to clarify the historical graphs and the tabulated data for October 1, 2020 through December 31, 2020.

Tables 2 through **5** present tabulated gas monitoring probe data for the monitoring period. Weekly water level readings were proposed by the July 2013 CAP and approved by the October 18, 2013 MDNR letter. These readings are presented as depth to water (from top of well). Results of weekly water level measurements for the monitoring period are presented in **Table 6**. Please note the “Quadrant” designation on **Tables 2-6** is based upon the March 2019 Operation, Maintenance, and Monitoring (OM&M) Plan. This plan was modified in June 2020. Therefore, this CAP Update includes the latest quadrant designations for the probes.

The following discussion highlights observations regarding methane data observed during this monitoring period. A site plan that depicts locations of the gas monitoring probes is presented in **Appendix C**.

Newly Elevated Compliance Probes

There were no newly elevated compliance probes during this quarterly review.

Probes with Greater Than or Equal to 2.5% Methane: Quarterly Review

The following probes exhibited methane concentrations above 2.5% for at least a portion of the current monitoring quarter: GMP-02, TMP-1S, TMP-2M, and TMP-3S.

Probes Below 2.5% Methane

The following probes exhibited methane concentrations less than 2.5% during the current quarterly monitoring period: GMP-01, GMP-03, GMP-4D, GMP-4S, GMP-05, GMP-5D, GMP-5S, GMP-06, GMP-6D, GMP-6S, GMP-07, GMP-7D, GMP-7S, GMP-08, GMP-09, GMP-10, GMP-11, GMP-12, GMP-13D, GMP-13S, GMP-14D, GMP-14S, GMP-15D, GMP-15S, GMP-16D,

GMP-16S, TMP-1D, TMP-1M, TMP-2D, TMP-2S, TMP-3D, TMP-3M, PZ-204A-SS, and PZ-204-SS.

Quarterly-Read Probes

Sentry Probes currently monitored on a quarterly basis are GMP-05, GMP-06, and GMP-07. During this quarterly monitoring period, measurements at these probes were performed on October 6, 2020. GMP-05, GMP-06, and GMP-07 exhibited methane concentrations below 2.5%. Sentry Probe GMP-04 was decommissioned in March 2014. Although Compliance Probe GMP-08 is listed as a quarterly-read probe in the July 2013 CAP, it was monitored more frequently during this monitoring period. GMP-08 exhibited methane concentrations above 2.5% during the beginning of the 2nd quarter 2019 but has remained below 2.5% methane since April 17, 2019.

Data Review

GMP-02 exhibited methane levels of greater than 2.5% for four weeks during the quarterly monitoring period. GMP-02 was back in compliance by the end of the quarterly monitoring period.

GMP-08 exhibited first-time measurements of greater than 2.5% methane on March 12, 2019. Subsequent to the March 12, 2019 detection, GMP-08 has previously been monitored more frequently. GMP-08 exhibited methane concentrations over 2.5% intermittently throughout the remainder of the first quarter 2019 and the beginning of second quarter 2019. However, GMP-08 methane measurements have been under the 2.5% threshold since April 17, 2019. A separate Landfill Gas Corrective Action Plan (LGCAP) for GMP-08 was submitted to the MDNR and to the St. Louis County Department of Public Health Air Pollution Control Program (SLCDPH-APCP) on March 26, 2019. The corrective action for GMP-08 is summarized in Sections 3.0 and 4.0 of this report.

3.0 RECENT GAS MIGRATION CONTROL EFFORTS

The July 2013 CAP and subsequent quarterly updates provide an overview of several ongoing and planned measures that are expected to reduce gas migration. The following are gas migration control efforts initiated, continued or completed in the fourth quarter of 2020.

Leachate Conveyance System

The operation of multiple upgraded lift stations around the perimeter of the South Quarry continued in the fourth quarter of 2020.

General LFG System Modifications and Improvements:

The following improvements have been completed in the South Quarry at the Bridgeton Landfill:

- Thirteen (13) landfill gas extraction wells were installed in the south quarry during the fourth quarter 2020 to increase landfill gas extraction capacity and liquid removal. The locations were targeted to provide source control adjacent to areas exhibiting migration, to provide odor control, and to enhance overall gas quality. Wells GEW-241, GEW-242, GEW-243, GEW-244, GEW-245, GEW-246, GEW-247, GEW-248, GEW-249, GEW-250, GEW-251, GEW-252, and GEW-253 were installed in October 2020. These 13 landfill gas extraction wells have been connected to the gas collection and control system and pumps have been installed in each well to remove liquid (**Appendix D**).
- Continued operation and monitoring of the “Pure-Air” system adjacent to Metropolitan Sewer District lift station just southwest of the South Quarry. Any vapors extracted from this gravel sump are directed to a “Pure-Air” system of activated carbon to allow for direct atmospheric discharge, removing a major air source from the landfill’s gas collection and control system (GCCS).
- Augmented gas well dewatering through use of additional downwell pneumatic pumps and liquid level monitoring. An ongoing systematic approach occurred this quarter to investigate all gas extraction wells in the southwest and southeast quadrants of the South Quarry, with the goal of increasing pumping and lowering water levels.
- Based on review of 2018 and 2019 gas data, methane concentrations in GMP-09 appeared to be affected by maintenance performed of the southwest portion of the interceptor trench, between access sumps TS-1, TS-2, and TS-3. Therefore, BL scheduled a vendor to remove sediment accumulation in these three sumps and

to jet clean the horizontal pipes between them. This cleaning has been done quarterly. The fourth quarter cleaning occurred on November 17-18, 2020.

The following data was collected at TS-1, TS-2, and TS-3 during the fourth quarter 2020:

- Liquid levels at the sumps;
 - System vacuum;
 - Vacuum at sumps;
 - Gas flow at sumps, and
 - Methane concentrations at the sump.
- BL installed a surface collector in the vicinity of GMP-03 (Southeast Surface Collector 2) in June 2019. This surface collector was installed and is continued to be operated to influence the methane concentrations in GMP-03.
 - BL installed a landfill gas collection trench near GMP-05 in October 2019. This trench was installed 50 feet in each direction away from the probe. The trench was connected to the gas system. Methane levels in GMP-05 decreased throughout the fourth quarter of 2019 and have remained in compliance since first quarter 2020. The performance of the collection trench for GMP-05 will continue to be monitored in the first quarter of 2021.
 - 35 temporary gas monitoring points were installed between April 24, 2020 and May 14, 2020 in 14 different locations in the southwest corner of the south quarry to assess migration in the TMP-1S, TMP-3S, and TMP-3M area. Monitoring of the temporary gas points began within second quarter and continued into the third quarter. The monitoring points were abandoned on July 24, 2020 in accordance with the “Soil Gas Monitoring Work Plan – Bridgeton Landfill” (December 31, 2019). The results were summarized in the “Soil Gas Monitoring Investigation Report” submitted to the MDNR on August 21, 2020 and approved on September 23, 2020.

Leachate Pretreatment Facility:

The leachate pretreatment facility continued operation during the fourth quarter of 2020.

4.0 PROPOSED, UPCOMING, AND ONGOING GAS MIGRATION CONTROL EFFORTS

Ongoing efforts have been successful in some areas, as suggested by the recent data in the GMP-14D area near the South Quarry's northeast corner and in the GMP-08 area near the North Quarry's northeast corner. The ongoing gas collection efforts within the South and North Quarry will continue. This includes the continuation of a program to maintain liquid levels in gas wells, including daily inspections and ongoing maintenance of gas extraction well pumps.

In order to better assess pump performance, BL collected monthly liquid levels in those gas extraction wells with pumps, beginning in February 2019. In addition, BL collected quarterly liquid levels in all gas extraction wells to review subsurface conditions over time to optimize pump installation and operation. These efforts continued during the fourth quarter 2020 and will continue through the first quarter 2021.

In addition, BL will continue to retain a vendor to remove sediment accumulation at sumps TS-1, TS-2, and TS-3 and to jet clean the horizontal pipes between the sumps on a quarterly basis. It is believed that the November 17-18, 2020 cleaning effort (as well as the subsequent efforts) is continuing to be influential in the decrease in methane concentrations at GMP-09.

Due to remedial efforts implemented by BL over the past year, probes GMP-05, GMP-08, GMP-09, GMP-14D, and TMP-2S exhibited compliant methane levels.

At the beginning of the first quarter 2020, the remaining problematic probes were GMP-02, GMP-03 on the south side of the South Quarry, and TMP-1S and TMP-3S near the southwest corner of the South Quarry. GMP-03 was back in compliance by the end of the first quarter and remained in compliance throughout the fourth quarter. GMP-02 was out of compliance for four weeks at the beginning of the fourth quarter but returned to compliant levels before the end of the quarter. While ongoing efforts have been made to address the TMP-1S/TMP-3S area, additional efforts are warranted.

Southwest Corner of the South Quarry

During the fourth quarter 2019, an assessment was performed for the additional gas wells (GEW-233 and GEW-234) that were installed to potentially mitigate exceedances at TMP-1S, TMP-3S, and TMP-3M. This assessment concluded that the additional wells have not been effective in obtaining compliant methane levels in TMP-1S and TMP-3S. The wells continued to be operated in the fourth quarter 2020. However, additional measures were proposed for the southwest corner of the South Quarry.

On December 31, 2019, Cornerstone Environmental Group, LLC submitted a report to MDNR entitled "Soil Gas Monitoring Work Plan – Bridgeton Landfill" (Work Plan) which proposed the installation of a series of temporary monitoring points in the southwest corner of the South Quarry. These proposed monitoring points were intended to determine the direction of combustible gas movement in the subsurface strata near TMP-1S and TMP-3S.

The locations of the points were proposed based on the current understanding of site geology, infrastructure, and potential natural and man-made gas transmission pathways. The points were installed utilizing a Hydraulic Soil Probe (HSP) down to the bedrock interface and completed using small-diameter PVC piping. Perforation elevations were defined by the results of the HSP borings, targeting any strata that either indicates the presence of combustible gas or possesses a higher permeability – such as sands, gravels, and weathered formations that may be conducive to gas transmission.

This work plan was approved on February 20, 2020 by the MDNR. Installation of the temporary monitoring points began on April 24, 2020. A total of 35 temporary monitoring points were installed in 14 separate locations (**Appendix E**). The installation was completed on May 14, 2020. Monitoring of each point began on May 19, 2020 and continued until July 22, 2020. The monitoring points were completely removed by July 24, 2020.

The “Soil Gas Monitoring Investigation Report” for the geoprobe installation and abandonment was submitted to the MDNR Waste Management Program (WMP) on August 21, 2020. This plan was approved by the MDNR WMP on September 23, 2020. The “Soil Gas Monitoring Corrective Action Plan” was submitted to the MDNR WMP on November 6, 2020 and proposed installation of soil vapor extraction (SVE) wells in the vicinity of TMP-1S and TMP-3S. This plan was approved on December 15, 2020. Installation of the SVE wells will begin in February 2021.

5.0 CONTINUED MONITORING AND REPORTING

BL will continue the gas probe monitoring and reporting as specified in Section 5.0 of the July 2013 CAP and Section XI.39 of the June 29, 2018 Final Consent Judgment.

TABLE 1

LIST OF LANDFILL GAS MONITORING PROBES

**Bridgeton Landfill
Landfill Gas Monitoring Probes
July 2013**

ID	CSV ID	POINT NAME	Ref Boring/installation Record	Type	Current Monitoring Frequency
GMP-01	BRIGMP01	MP01	GMP-01	Compliance probe	weekly
GMP-02	BRIGMP02	MP02	GMP-02	Compliance probe	weekly
GMP-03	BRIGMP03	MP03	GMP-03	Compliance probe	weekly
GMP-04*	BRIGMP04	MP04	GMP-04	Sentry probe	quarterly
GMP-05	BRIGMP05	MP05	GMP-05	Sentry probe	quarterly
GMP-06	BRIGMP06	MP06	PZ-201-SS	Sentry probe	quarterly
GMP-07	BRIGMP07	MP07	PZ-200-SS	Sentry probe	quarterly
GMP-08	BRIGMP08	MP08	GMP-08	Compliance probe	quarterly
GMP-09	BRIGMP09	MP09	GMP-09	Public Safety Probe	weekly
GMP-10	BRIGMP10	MP10	GMP-10	Public Safety Probe	weekly
GMP-11	BRIGMP11	MP11	GMP-11	Public Safety Probe	weekly
GMP-12	BRIGMP12	MP12	GMP-12	Public Safety Probe	weekly
GMP-4S	BRIGMP4S	BRIGMP4S	GMP-04	Compliance nested probe	weekly
GMP-4D	BRIGMP4D	BRIGMP4D	GMP-04	Compliance nested probe	weekly
GMP-5S	BRIGMP5S	BRIGMP5S	GMP-05	Compliance nested probe	weekly
GMP-5D	BRIGMP5D	BRIGMP5D	GMP-05	Compliance nested probe	weekly
GMP-6S	BRIGMP6S	BRIGMP6S	GMP-06	Compliance nested probe	weekly
GMP-6D	BRIGMP6D	BRIGMP6D	GMP-06	Compliance nested probe	weekly
GMP-7S	BRIGMP7S	BRIGMP7S	GMP-07	Compliance nested probe	weekly
GMP-7D	BRIGMP7D	BRIGMP7D	GMP-07	Compliance nested probe	weekly
GMP-13S	BRGMP13S	BRGMP13S	GMP-13	Compliance nested probe	weekly
GMP-13D	BRGMP13D	BRGMP13D	GMP-13	Compliance nested probe	weekly
GMP-14S	BRGMP14S	BRGMP14S	GMP-14	Compliance nested probe	weekly
GMP-14D	BRGMP14D	BRGMP14D	GMP-14	Compliance nested probe	weekly
GMP-15S	BRGMP15S	BRGMP15S	GMP-15	Compliance nested probe	weekly
GMP-15D	BRGMP15D	BRGMP15D	GMP-15	Compliance nested probe	weekly
GMP-16S	BRGMP16S	BRGMP16S	GMP-16	Compliance nested probe	weekly
GMP-16D	BRGMP16D	BRGMP16D	GMP-16	Compliance nested probe	weekly
TMP-1S	BRITMP1S	BRITMP1S	TMP-01	Investigative nested probe	weekly
TMP-1M	BRITMP1M	BRITMP1M	TMP-01	Investigative nested probe	weekly
TMP-1D	BRITMP1D	BRITMP1D	TMP-01	Investigative nested probe	weekly
TMP-2S	BRITMP2S	BRITMP2S	TMP-02	Investigative nested probe	weekly
TMP-2M	BRITMP2M	BRITMP2M	TMP-02	Investigative nested probe	weekly
TMP-2D	BRITMP2D	BRITMP2D	TMP-02	Investigative nested probe	weekly
TMP-3S	BRITMP3S	BRITMP3S	TMP-03	Investigative nested probe	weekly
TMP-3M	BRITMP3M	BRITMP3M	TMP-03	Investigative nested probe	weekly
TMP-3D	BRITMP3D	BRITMP3D	TMP-03	Investigative nested probe	weekly
PZ-204-SS	PZ2040SS	4OSS	PZ-204-SS	Public Safety Probe	weekly
PZ-204A-SS	PZ204ASS	4ASS	PZ-204-ASS	Public Safety Probe	weekly

* Well has been decommissioned

TABLE 2

COMPLIANCE GAS MONITORING PROBE DATA

OCTOBER 01, 2020 – DECEMBER 31, 2020

Point Name	Frequency	Quadrant	Record Date	CH4 (%)	CO2 (%)	O2 (%)	Balance Gas (%)	Barometric Pressure	Relative Pressure
GMP-01	Weekly	2	10/6/2020	0.0	0.2	20.8	79.0	30	0.00
GMP-01	Weekly	2	10/13/2020	0.0	0.5	21.2	78.3	30	0.00
GMP-01	Weekly	2	10/20/2020	0.0	0.5	20.8	78.7	30	0.01
GMP-01	Weekly	2	10/27/2020	0.0	0.2	21.0	78.8	30	0.01
GMP-01	Weekly	2	11/3/2020	0.0	0.1	21.0	78.9	30	0.01
GMP-01	Weekly	2	11/9/2020	0.0	0.2	20.9	78.9	30	0.00
GMP-01	Weekly	2	11/17/2020	0.0	0.1	20.9	79.0	30	0.01
GMP-01	Weekly	2	11/23/2020	0.0	0.3	21.0	78.7	30	-0.01
GMP-01	Weekly	2	12/1/2020	0.0	0.6	20.9	78.5	30	0.01
GMP-01	Weekly	2	12/8/2020	0.0	0.1	21.0	78.9	30	-0.01
GMP-01	Weekly	2	12/15/2020	0.0	0.5	21.0	78.5	30	0.01
GMP-01	Weekly	2	12/22/2020	0.0	0.1	21.0	78.9	30	-0.01
GMP-01	Weekly	2	12/29/2020	0.0	0.2	21.1	78.7	30	0.00
GMP-02	Weekly	4	10/6/2020	0.0	0.9	19.1	80.0	30	0.03
GMP-02	Weekly	4	10/13/2020	18.5	11.3	13.3	56.9	30	0.01
GMP-02	Weekly	4	10/20/2020	20.9	13.2	12.5	53.4	30	-0.05
GMP-02	Weekly	4	10/27/2020	0.0	0.3	21.1	78.6	30	0.09
GMP-02	Weekly	4	11/3/2020	22.6	12.5	13.3	51.6	30	0.01
GMP-02	Weekly	4	11/9/2020	28.8	17.1	11.1	43.0	30	0.15
GMP-02	Weekly	4	11/17/2020	0.1	0.6	20.8	78.5	30	-5.07
GMP-02	Weekly	4	11/23/2020	0.0	0.7	20.9	78.4	30	-5.75
GMP-02	Weekly	4	12/1/2020	0.4	1.0	20.7	77.9	30	-2.36
GMP-02	Weekly	4	12/8/2020	0.0	0.6	20.9	78.5	30	0.04
GMP-02	Weekly	4	12/15/2020	0.0	1.3	20.6	78.1	30	0.07
GMP-02	Weekly	4	12/22/2020	0.0	0.6	21.0	78.4	30	0.05
GMP-02	Weekly	4	12/29/2020	0.0	1.1	20.8	78.1	30	-0.03
GMP-03	Weekly	4	10/6/2020	0.5	20.6	0.1	78.8	30	0.00
GMP-03	Weekly	4	10/13/2020	0.7	19.9	0.0	79.4	30	0.01
GMP-03	Weekly	4	10/20/2020	1.1	19.1	0.1	79.7	30	0.01
GMP-03	Weekly	4	10/27/2020	0.9	18.5	0.1	80.5	30	0.01
GMP-03	Weekly	4	11/3/2020	1.0	18.9	0.2	79.9	30	0.01
GMP-03	Weekly	4	11/9/2020	1.3	18.2	0.0	80.5	30	0.00
GMP-03	Weekly	4	11/17/2020	1.0	16.1	0.0	82.9	30	0.01
GMP-03	Weekly	4	11/23/2020	1.1	17.2	0.0	81.7	30	0.00
GMP-03	Weekly	4	12/1/2020	0.3	1.8	13.6	84.3	30	0.00
GMP-03	Weekly	4	12/8/2020	0.4	4.6	10.6	84.4	30	0.04
GMP-03	Weekly	4	12/15/2020	0.9	15.6	0.2	83.3	30	-0.05
GMP-03	Weekly	4	12/22/2020	0.9	14.9	0.2	84.0	30	0.01
GMP-03	Weekly	4	12/29/2020	0.8	15.5	0.4	83.3	30	0.02
GMP-08	Weekly	1	10/6/2020	0.0	2.9	15.6	81.5	30	-0.01

Point Name	Frequency	Quadrant	Record Date	CH4 (%)	CO2 (%)	O2 (%)	Balance Gas (%)	Barometric Pressure	Relative Pressure
GMP-08	Weekly	1	10/13/2020	0.0	1.3	17.9	80.8	30	-0.01
GMP-08	Weekly	1	10/20/2020	0.0	4.7	14.6	80.7	30	0.01
GMP-08	Weekly	1	10/27/2020	0.0	2.3	16.7	81.0	30	0.06
GMP-08	Weekly	1	11/3/2020	0.0	3.0	15.8	81.2	30	0.02
GMP-08	Weekly	1	11/9/2020	0.0	2.6	17.0	80.4	30	0.02
GMP-08	Weekly	1	11/17/2020	0.0	2.2	17.4	80.4	30	0.02
GMP-08	Weekly	1	11/23/2020	0.0	4.3	15.5	80.2	30	0.03
GMP-08	Weekly	1	12/1/2020	0.0	1.7	14.6	83.7	30	-0.01
GMP-08	Weekly	1	12/8/2020	0.0	2.0	16.9	81.1	30	0.03
GMP-08	Weekly	1	12/15/2020	0.0	1.4	17.3	81.3	30	0.08
GMP-08	Weekly	1	12/22/2020	0.0	0.9	18.8	80.3	30	0.02
GMP-08	Weekly	1	12/29/2020	0.0	0.7	18.8	80.5	30	0.09
GMP-4D	Weekly	3	10/6/2020	0.0	0.6	19.8	79.6	30	-0.01
GMP-4D	Weekly	3	10/13/2020	0.0	0.8	19.5	79.7	30	0.01
GMP-4D	Weekly	3	10/20/2020	0.0	1.2	19.8	79.0	30	-0.07
GMP-4D	Weekly	3	10/27/2020	0.0	0.3	20.8	78.9	30	0.01
GMP-4D	Weekly	3	11/3/2020	0.0	0.0	20.5	79.5	30	0.00
GMP-4D	Weekly	3	11/9/2020	0.0	0.3	20.2	79.5	30	-0.01
GMP-4D	Weekly	3	11/17/2020	0.0	0.3	20.9	78.8	30	0.01
GMP-4D	Weekly	3	11/23/2020	0.0	0.3	20.9	78.8	30	0.01
GMP-4D	Weekly	3	12/1/2020	0.0	0.8	20.8	78.4	30	-0.04
GMP-4D	Weekly	3	12/8/2020	0.0	0.9	20.8	78.3	30	0.02
GMP-4D	Weekly	3	12/15/2020	0.0	1.1	20.6	78.3	30	0.01
GMP-4D	Weekly	3	12/22/2020	0.0	0.2	21.0	78.8	30	-0.15
GMP-4D	Weekly	3	12/29/2020	0.0	1.3	20.6	78.1	30	-0.02
GMP-4S	Weekly	3	10/6/2020	0.0	2.8	15.2	82.0	30	-0.01
GMP-4S	Weekly	3	10/13/2020	0.0	3.0	14.7	82.3	30	0.00
GMP-4S	Weekly	3	10/20/2020	0.0	3.1	16.5	80.4	30	0.00
GMP-4S	Weekly	3	10/27/2020	0.0	2.3	17.4	80.3	30	0.00
GMP-4S	Weekly	3	11/3/2020	0.0	0.6	18.9	80.5	30	-0.01
GMP-4S	Weekly	3	11/9/2020	0.0	1.2	18.7	80.1	30	-0.01
GMP-4S	Weekly	3	11/17/2020	0.0	1.2	18.2	80.6	30	0.00
GMP-4S	Weekly	3	11/23/2020	0.0	1.4	17.4	81.2	30	0.00
GMP-4S	Weekly	3	12/1/2020	0.0	1.0	18.9	80.1	30	0.02
GMP-4S	Weekly	3	12/8/2020	0.0	1.2	18.7	80.1	30	0.00
GMP-4S	Weekly	3	12/15/2020	0.0	1.5	18.7	79.8	30	0.01
GMP-4S	Weekly	3	12/22/2020	0.0	1.3	19.4	79.3	30	0.00
GMP-4S	Weekly	3	12/29/2020	0.0	1.3	18.6	80.1	30	0.01
GMP-5D	Weekly	3	10/6/2020	0.0	1.3	19.4	79.3	30	0.00
GMP-5D	Weekly	3	10/13/2020	0.0	0.9	19.5	79.6	30	0.02

Point Name	Frequency	Quadrant	Record Date	CH4 (%)	CO2 (%)	O2 (%)	Balance Gas (%)	Barometric Pressure	Relative Pressure
GMP-5D	Weekly	3	10/20/2020	0.0	1.0	19.8	79.2	30	0.02
GMP-5D	Weekly	3	10/27/2020	0.0	0.8	20.5	78.7	30	0.01
GMP-5D	Weekly	3	11/3/2020	0.0	0.0	20.3	79.7	30	0.02
GMP-5D	Weekly	3	11/9/2020	0.0	0.3	20.3	79.4	30	0.02
GMP-5D	Weekly	3	11/17/2020	0.0	0.3	21.0	78.7	30	0.03
GMP-5D	Weekly	3	11/23/2020	0.0	0.3	20.9	78.8	30	0.02
GMP-5D	Weekly	3	12/1/2020	0.0	0.5	21.1	78.4	30	0.08
GMP-5D	Weekly	3	12/8/2020	0.0	0.3	20.9	78.8	30	0.04
GMP-5D	Weekly	3	12/15/2020	0.0	0.6	20.7	78.7	30	0.03
GMP-5D	Weekly	3	12/22/2020	0.0	1.0	21.0	78.0	30	0.05
GMP-5D	Weekly	3	12/29/2020	0.0	0.5	21.0	78.5	30	0.01
GMP-5S	Weekly	3	10/6/2020	0.0	5.1	16.4	78.5	30	-0.01
GMP-5S	Weekly	3	10/13/2020	0.0	4.3	16.6	79.1	30	-0.03
GMP-5S	Weekly	3	10/20/2020	0.0	2.5	18.8	78.7	30	0.01
GMP-5S	Weekly	3	10/27/2020	0.0	2.1	19.8	78.1	30	0.00
GMP-5S	Weekly	3	11/3/2020	0.0	0.4	20.0	79.6	30	0.00
GMP-5S	Weekly	3	11/9/2020	0.0	0.6	20.1	79.3	30	-0.02
GMP-5S	Weekly	3	11/17/2020	0.0	0.8	20.8	78.4	30	0.01
GMP-5S	Weekly	3	11/23/2020	0.0	0.8	20.7	78.5	30	0.01
GMP-5S	Weekly	3	12/1/2020	0.0	1.0	20.9	78.1	30	0.01
GMP-5S	Weekly	3	12/8/2020	0.0	0.7	20.7	78.6	30	0.01
GMP-5S	Weekly	3	12/15/2020	0.0	1.2	20.2	78.6	30	0.02
GMP-5S	Weekly	3	12/22/2020	0.0	4.0	20.1	75.9	30	0.00
GMP-5S	Weekly	3	12/29/2020	0.0	1.0	20.7	78.3	30	0.00
GMP-6D	Weekly	1	10/6/2020	0.0	0.1	20.3	79.6	30	0.02
GMP-6D	Weekly	1	10/13/2020	0.0	0.1	20.1	79.8	30	-0.02
GMP-6D	Weekly	1	10/20/2020	0.0	0.1	20.5	79.4	30	-0.02
GMP-6D	Weekly	1	10/27/2020	0.0	0.1	21.1	78.8	30	0.02
GMP-6D	Weekly	1	11/3/2020	0.0	0.0	20.8	79.2	30	0.00
GMP-6D	Weekly	1	11/9/2020	0.0	0.1	20.6	79.3	30	0.00
GMP-6D	Weekly	1	11/17/2020	0.0	0.0	20.9	79.1	30	-3.12
GMP-6D	Weekly	1	11/23/2020	0.0	0.2	21.0	78.8	30	-0.01
GMP-6D	Weekly	1	12/1/2020	0.0	0.2	21.0	78.8	30	0.05
GMP-6D	Weekly	1	12/8/2020	0.0	0.3	20.9	78.8	30	0.02
GMP-6D	Weekly	1	12/15/2020	0.0	0.4	20.8	78.8	30	0.02
GMP-6D	Weekly	1	12/22/2020	0.0	0.1	20.9	79.0	30	0.00
GMP-6D	Weekly	1	12/29/2020	0.0	0.4	21.0	78.6	30	0.00
GMP-6S	Weekly	1	10/6/2020	0.0	0.4	19.8	79.8	30	-0.01
GMP-6S	Weekly	1	10/13/2020	0.0	0.3	19.6	80.1	30	0.02
GMP-6S	Weekly	1	10/20/2020	0.0	0.3	20.3	79.4	30	0.02

Point Name	Frequency	Quadrant	Record Date	CH4 (%)	CO2 (%)	O2 (%)	Balance Gas (%)	Barometric Pressure	Relative Pressure
GMP-6S	Weekly	1	10/27/2020	0.0	0.3	20.9	78.8	30	0.02
GMP-6S	Weekly	1	11/3/2020	0.0	0.0	20.5	79.5	30	0.03
GMP-6S	Weekly	1	11/9/2020	0.0	0.2	20.3	79.5	30	0.00
GMP-6S	Weekly	1	11/17/2020	0.0	0.3	20.9	78.8	30	0.00
GMP-6S	Weekly	1	11/23/2020	0.0	0.6	20.5	78.9	30	0.02
GMP-6S	Weekly	1	12/1/2020	0.0	0.6	20.5	78.9	30	0.04
GMP-6S	Weekly	1	12/8/2020	0.0	0.5	20.6	78.9	30	0.03
GMP-6S	Weekly	1	12/15/2020	0.0	0.4	20.3	79.3	30	0.06
GMP-6S	Weekly	1	12/22/2020	0.0	0.7	20.7	78.6	30	0.05
GMP-6S	Weekly	1	12/29/2020	0.0	0.4	20.7	78.9	30	0.02
GMP-7D	Weekly	1	10/6/2020	0.0	0.0	6.1	93.9	30	-0.01
GMP-7D	Weekly	1	10/13/2020	0.0	0.6	19.8	79.6	30	0.00
GMP-7D	Weekly	1	10/20/2020	0.0	0.5	20.2	79.3	30	-0.01
GMP-7D	Weekly	1	10/27/2020	0.0	0.5	20.6	78.9	30	0.00
GMP-7D	Weekly	1	11/3/2020	0.0	0.0	21.0	79.0	30	-0.01
GMP-7D	Weekly	1	11/9/2020	0.0	0.2	20.4	79.4	30	-0.01
GMP-7D	Weekly	1	11/17/2020	0.0	0.2	20.6	79.2	30	0.00
GMP-7D	Weekly	1	11/23/2020	0.0	0.2	20.9	78.9	30	0.00
GMP-7D	Weekly	1	12/1/2020	0.0	1.1	20.8	78.1	30	0.00
GMP-7D	Weekly	1	12/8/2020	0.0	1.1	20.4	78.5	30	0.00
GMP-7D	Weekly	1	12/15/2020	0.0	1.2	20.3	78.5	30	0.00
GMP-7D	Weekly	1	12/22/2020	0.0	1.2	20.2	78.6	30	-0.01
GMP-7D	Weekly	1	12/29/2020	0.0	1.6	20.3	78.1	30	0.00
GMP-7S	Weekly	1	10/6/2020	0.0	5.1	6.2	88.7	30	0.00
GMP-7S	Weekly	1	10/13/2020	0.0	4.8	7.2	88.0	30	0.01
GMP-7S	Weekly	1	10/20/2020	0.0	3.1	7.3	89.6	30	0.00
GMP-7S	Weekly	1	10/27/2020	0.0	2.0	6.6	91.4	30	0.01
GMP-7S	Weekly	1	11/3/2020	0.0	1.9	5.5	92.6	30	-0.01
GMP-7S	Weekly	1	11/9/2020	0.0	3.0	6.4	90.6	30	0.00
GMP-7S	Weekly	1	11/17/2020	0.0	1.1	4.9	94.0	30	0.00
GMP-7S	Weekly	1	11/23/2020	0.0	1.2	6.5	92.3	30	0.01
GMP-7S	Weekly	1	12/1/2020	0.0	3.1	5.9	91.0	30	0.00
GMP-7S	Weekly	1	12/8/2020	0.0	3.2	5.7	91.1	30	0.00
GMP-7S	Weekly	1	12/15/2020	0.0	2.1	6.8	91.1	30	0.01
GMP-7S	Weekly	1	12/22/2020	0.0	2.5	6.9	90.6	30	0.00
GMP-7S	Weekly	1	12/29/2020	0.0	1.7	7.7	90.6	30	0.00
GMP-13D	Weekly	4	10/6/2020	0.0	0.8	20.2	79.0	30	0.01
GMP-13D	Weekly	4	10/13/2020	0.0	0.9	19.8	79.3	30	0.02
GMP-13D	Weekly	4	10/20/2020	0.0	1.3	20.3	78.4	30	0.02
GMP-13D	Weekly	4	10/27/2020	0.0	1.8	20.7	77.5	30	0.02

Point Name	Frequency	Quadrant	Record Date	CH4 (%)	CO2 (%)	O2 (%)	Balance Gas (%)	Barometric Pressure	Relative Pressure
GMP-13D	Weekly	4	11/3/2020	0.0	0.0	20.8	79.2	30	0.01
GMP-13D	Weekly	4	11/9/2020	0.0	0.4	20.6	79.0	30	0.04
GMP-13D	Weekly	4	11/17/2020	0.0	0.7	21.0	78.3	30	0.02
GMP-13D	Weekly	4	11/23/2020	0.0	0.6	20.9	78.5	30	0.02
GMP-13D	Weekly	4	12/1/2020	0.0	2.5	20.4	77.1	30	0.00
GMP-13D	Weekly	4	12/8/2020	0.0	2.3	20.5	77.2	30	-0.06
GMP-13D	Weekly	4	12/15/2020	0.0	3.5	20.2	76.3	30	-0.06
GMP-13D	Weekly	4	12/22/2020	0.0	0.9	20.8	78.3	30	0.02
GMP-13D	Weekly	4	12/29/2020	0.0	2.8	20.4	76.8	30	0.03
GMP-13S	Weekly	4	10/6/2020	0.0	7.5	13.9	78.6	30	-0.01
GMP-13S	Weekly	4	10/13/2020	0.0	6.4	14.4	79.2	30	-0.01
GMP-13S	Weekly	4	10/20/2020	0.0	7.0	14.7	78.3	30	0.00
GMP-13S	Weekly	4	10/27/2020	0.0	7.5	15.0	77.5	30	0.00
GMP-13S	Weekly	4	11/3/2020	0.0	5.3	15.2	79.5	30	0.00
GMP-13S	Weekly	4	11/9/2020	0.0	5.1	15.7	79.2	30	0.00
GMP-13S	Weekly	4	11/17/2020	0.0	4.0	15.1	80.9	30	0.00
GMP-13S	Weekly	4	11/23/2020	0.0	3.7	14.4	81.9	30	-0.01
GMP-13S	Weekly	4	12/1/2020	0.0	4.2	14.7	81.1	30	-0.02
GMP-13S	Weekly	4	12/8/2020	0.0	5.4	14.7	79.9	30	-0.08
GMP-13S	Weekly	4	12/15/2020	0.0	7.6	14.9	77.5	30	0.02
GMP-13S	Weekly	4	12/22/2020	0.0	1.8	16.7	81.5	30	0.00
GMP-13S	Weekly	4	12/29/2020	0.0	6.8	16.3	76.9	30	0.00
GMP-14D	Weekly	3	10/6/2020	0.0	0.6	19.8	79.6	30	0.00
GMP-14D	Weekly	3	10/13/2020	0.0	1.0	19.6	79.4	30	0.00
GMP-14D	Weekly	3	10/20/2020	0.0	1.5	19.9	78.6	30	0.00
GMP-14D	Weekly	3	10/27/2020	0.0	1.5	20.5	78.0	30	0.00
GMP-14D	Weekly	3	11/3/2020	0.0	0.0	20.4	79.6	30	0.03
GMP-14D	Weekly	3	11/9/2020	0.0	0.3	20.2	79.5	30	-0.02
GMP-14D	Weekly	3	11/17/2020	0.0	0.9	20.5	78.6	30	0.02
GMP-14D	Weekly	3	11/23/2020	0.0	1.0	20.4	78.6	30	0.01
GMP-14D	Weekly	3	12/1/2020	0.0	3.2	20.0	76.8	30	-0.25
GMP-14D	Weekly	3	12/8/2020	0.0	3.0	20.2	76.8	30	0.01
GMP-14D	Weekly	3	12/15/2020	0.0	3.6	20.0	76.4	30	0.02
GMP-14D	Weekly	3	12/22/2020	0.0	3.1	20.8	76.1	30	0.03
GMP-14D	Weekly	3	12/29/2020	0.0	2.9	20.4	76.7	30	0.04
GMP-14S	Weekly	3	10/6/2020	0.0	6.5	4.4	89.1	30	-0.01
GMP-14S	Weekly	3	10/13/2020	0.0	6.5	5.1	88.4	30	-0.01
GMP-14S	Weekly	3	10/20/2020	0.0	8.2	2.5	89.3	30	0.00
GMP-14S	Weekly	3	10/27/2020	0.0	7.6	2.4	90.0	30	-0.01
GMP-14S	Weekly	3	11/3/2020	0.0	7.3	4.2	88.5	30	0.00

Point Name	Frequency	Quadrant	Record Date	CH4 (%)	CO2 (%)	O2 (%)	Balance Gas (%)	Barometric Pressure	Relative Pressure
GMP-14S	Weekly	3	11/9/2020	0.0	6.6	6.1	87.3	30	0.00
GMP-14S	Weekly	3	11/17/2020	0.0	6.6	4.3	89.1	30	0.00
GMP-14S	Weekly	3	11/23/2020	0.0	6.7	4.8	88.5	30	0.00
GMP-14S	Weekly	3	12/1/2020	0.0	5.4	4.0	90.6	30	0.06
GMP-14S	Weekly	3	12/8/2020	0.0	5.3	2.6	92.1	30	0.00
GMP-14S	Weekly	3	12/15/2020	0.0	5.8	2.7	91.5	30	0.01
GMP-14S	Weekly	3	12/22/2020	0.0	4.1	2.1	93.8	30	0.00
GMP-14S	Weekly	3	12/29/2020	0.0	3.4	3.0	93.6	30	0.01
GMP-15D	Weekly	1	10/6/2020	0.0	0.1	20.2	79.7	30	0.04
GMP-15D	Weekly	1	10/13/2020	0.0	0.2	20.0	79.8	30	-0.01
GMP-15D	Weekly	1	10/20/2020	0.0	0.3	20.2	79.5	30	-0.01
GMP-15D	Weekly	1	10/27/2020	0.0	0.6	20.7	78.7	30	0.00
GMP-15D	Weekly	1	11/3/2020	0.0	0.0	20.4	79.6	30	0.02
GMP-15D	Weekly	1	11/9/2020	0.0	0.3	20.3	79.4	30	0.12
GMP-15D	Weekly	1	11/17/2020	0.0	0.5	20.6	78.9	30	0.27
GMP-15D	Weekly	1	11/23/2020	0.0	0.6	20.8	78.6	30	0.01
GMP-15D	Weekly	1	12/1/2020	0.0	1.3	20.7	78.0	30	0.07
GMP-15D	Weekly	1	12/8/2020	0.0	1.4	20.4	78.2	30	0.11
GMP-15D	Weekly	1	12/15/2020	0.0	1.5	20.3	78.2	30	0.06
GMP-15D	Weekly	1	12/22/2020	0.0	1.6	20.3	78.1	30	0.16
GMP-15D	Weekly	1	12/29/2020	0.0	1.2	20.6	78.2	30	0.04
GMP-15S	Weekly	1	10/6/2020	0.0	0.1	20.2	79.7	30	0.03
GMP-15S	Weekly	1	10/13/2020	0.0	0.2	19.9	79.9	30	0.02
GMP-15S	Weekly	1	10/20/2020	0.0	0.2	20.2	79.6	30	0.31
GMP-15S	Weekly	1	10/27/2020	0.0	1.0	20.4	78.6	30	1.41
GMP-15S	Weekly	1	11/3/2020	0.0	1.6	19.8	78.6	30	0.08
GMP-15S	Weekly	1	11/9/2020	0.0	1.7	19.8	78.5	30	0.18
GMP-15S	Weekly	1	11/17/2020	0.0	1.8	20.0	78.2	30	0.48
GMP-15S	Weekly	1	11/23/2020	0.0	2.2	20.1	77.7	30	0.04
GMP-15S	Weekly	1	12/1/2020	0.0	1.7	20.1	78.2	30	0.14
GMP-15S	Weekly	1	12/8/2020	0.0	1.3	20.3	78.4	30	0.13
GMP-15S	Weekly	1	12/15/2020	0.0	0.9	20.2	78.9	30	0.11
GMP-15S	Weekly	1	12/22/2020	0.0	1.2	20.0	78.8	30	0.19
GMP-15S	Weekly	1	12/29/2020	0.0	0.9	20.4	78.7	30	0.08
GMP-16D	Weekly	1	10/6/2020	0.0	0.8	21.0	78.2	30	-0.01
GMP-16D	Weekly	1	10/13/2020	0.0	0.7	19.7	79.6	30	-0.27
GMP-16D	Weekly	1	10/20/2020	0.0	1.4	20.2	78.4	30	0.01
GMP-16D	Weekly	1	10/27/2020	0.0	1.7	19.6	78.7	30	-0.37
GMP-16D	Weekly	1	11/3/2020	0.0	0.0	20.3	79.7	30	0.00
GMP-16D	Weekly	1	11/9/2020	0.0	0.7	20.0	79.3	30	-0.01

Point Name	Frequency	Quadrant	Record Date	CH4 (%)	CO2 (%)	O2 (%)	Balance Gas (%)	Barometric Pressure	Relative Pressure
GMP-16D	Weekly	1	11/17/2020	0.0	0.9	19.6	79.5	30	-1.93
GMP-16D	Weekly	1	11/23/2020	0.0	0.1	20.4	79.5	30	1.59
GMP-16D	Weekly	1	12/1/2020	0.0	1.5	20.7	77.8	30	-0.01
GMP-16D	Weekly	1	12/8/2020	0.0	0.9	20.5	78.6	30	0.00
GMP-16D	Weekly	1	12/15/2020	0.0	3.3	19.4	77.3	30	-1.69
GMP-16D	Weekly	1	12/22/2020	0.0	1.5	20.2	78.3	30	0.02
GMP-16D	Weekly	1	12/29/2020	0.0	3.4	19.9	76.7	30	0.00
GMP-16S	Weekly	1	10/6/2020	0.0	13.6	3.0	83.4	30	0.01
GMP-16S	Weekly	1	10/13/2020	0.0	12.3	4.4	83.3	30	0.00
GMP-16S	Weekly	1	10/20/2020	0.0	3.4	6.5	90.1	30	-0.07
GMP-16S	Weekly	1	10/27/2020	0.0	10.0	6.1	83.9	30	-0.27
GMP-16S	Weekly	1	11/3/2020	0.0	9.5	6.5	84.0	30	0.05
GMP-16S	Weekly	1	11/9/2020	0.0	7.1	9.5	83.4	30	0.01
GMP-16S	Weekly	1	11/17/2020	0.0	8.3	7.6	84.1	30	-0.43
GMP-16S	Weekly	1	11/23/2020	0.0	0.0	21.0	79.0	30	-0.03
GMP-16S	Weekly	1	12/1/2020	0.0	1.9	11.5	86.6	30	0.08
GMP-16S	Weekly	1	12/8/2020	0.0	1.3	16.8	81.9	30	0.01
GMP-16S	Weekly	1	12/15/2020	0.0	3.1	11.5	85.4	30	0.10
GMP-16S	Weekly	1	12/22/2020	0.0	2.0	15.8	82.2	30	0.03
GMP-16S	Weekly	1	12/29/2020	0.0	3.3	12.9	83.8	30	0.09

TABLE 3

SENTRY GAS MONITORING PROBE DATA

OCTOBER 01, 2020 – DECEMBER 31, 2020

Point Name	Frequency	Quadrant	Record Date	CH4 (%)	CO2 (%)	O2 (%)	Balance Gas (%)	Barometric Pressure	Relative Pressure
GMP-05	Quarterly	3	10/6/2020	1.4	0.3	19.9	78.4	30	-0.03
GMP-06	Quarterly	1	10/6/2020	0.0	9.0	16.3	74.7	30	0.00
GMP-07	Quarterly	1	10/6/2020	0.0	6.5	11.9	81.6	30	0.01

TABLE 4

INVESTIGATIVE GAS MONITORING PROBE DATA

OCTOBER 01, 2020 – DECEMBER 31, 2020

Point Name	Frequency	Quadrant	Record Date	CH4 (%)	CO2 (%)	O2 (%)	Balance Gas (%)	Barometric Pressure	Relative Pressure
TMP-1D	Weekly	2	10/6/2020	0.0	0.0	20.9	79.1	30	-0.16
TMP-1D	Weekly	2	10/13/2020	0.0	0.0	21.0	79.0	30	0.75
TMP-1D	Weekly	2	10/20/2020	0.1	0.5	21.0	78.4	30	0.05
TMP-1D	Weekly	2	10/27/2020	0.0	0.1	21.0	78.9	30	-0.41
TMP-1D	Weekly	2	11/3/2020	0.0	0.1	21.0	78.9	30	-0.05
TMP-1D	Weekly	2	11/9/2020	0.0	0.1	21.1	78.8	30	0.65
TMP-1D	Weekly	2	11/17/2020	0.0	0.0	21.0	79.0	30	-0.91
TMP-1D	Weekly	2	11/23/2020	0.0	0.1	21.1	78.8	30	0.92
TMP-1D	Weekly	2	12/1/2020	0.0	0.1	21.0	78.9	30	0.70
TMP-1D	Weekly	2	12/8/2020	0.0	0.1	21.1	78.8	30	0.57
TMP-1D	Weekly	2	12/15/2020	0.0	0.0	21.0	79.0	30	-0.40
TMP-1D	Weekly	2	12/22/2020	0.0	0.2	20.9	78.9	30	0.69
TMP-1D	Weekly	2	12/29/2020	0.0	0.2	21.1	78.7	30	-0.31
TMP-1M	Weekly	2	10/6/2020	0.1	0.2	21.0	78.7	30	-0.04
TMP-1M	Weekly	2	10/13/2020	0.0	0.2	21.1	78.7	30	-0.34
TMP-1M	Weekly	2	10/20/2020	0.3	1.6	20.7	77.4	30	-0.02
TMP-1M	Weekly	2	10/27/2020	0.5	1.9	20.9	76.7	30	-4.78
TMP-1M	Weekly	2	11/3/2020	0.4	1.4	21.1	77.1	30	-0.03
TMP-1M	Weekly	2	11/9/2020	0.1	0.1	21.0	78.8	30	-0.15
TMP-1M	Weekly	2	11/17/2020	0.1	0.3	21.0	78.6	30	-0.22
TMP-1M	Weekly	2	11/23/2020	0.1	0.2	21.0	78.7	30	-1.90
TMP-1M	Weekly	2	12/1/2020	0.0	0.2	21.0	78.8	30	-0.26
TMP-1M	Weekly	2	12/8/2020	0.0	0.1	21.0	78.9	30	-1.81
TMP-1M	Weekly	2	12/15/2020	0.0	0.2	21.1	78.7	30	-0.97
TMP-1M	Weekly	2	12/22/2020	0.0	0.5	20.8	78.7	30	0.00
TMP-1M	Weekly	2	12/29/2020	0.0	4.0	20.8	75.2	30	-0.02
TMP-1S	Weekly	2	10/6/2020	56.8	31.9	0.1	11.2	30	0.00
TMP-1S	Weekly	2	10/13/2020	25.6	28.0	0.1	46.3	30	0.00
TMP-1S	Weekly	2	10/20/2020	43.9	30.2	0.2	25.7	30	0.00
TMP-1S	Weekly	2	10/27/2020	57.1	31.0	0.3	11.6	30	0.04
TMP-1S	Weekly	2	11/3/2020	59.5	31.3	0.3	8.9	30	0.00
TMP-1S	Weekly	2	11/9/2020	61.2	32.7	0.1	6.0	30	0.02
TMP-1S	Weekly	2	11/17/2020	34.6	26.6	0.1	38.7	30	-0.03
TMP-1S	Weekly	2	11/23/2020	57.0	23.7	0.7	18.6	30	-0.01
TMP-1S	Weekly	2	12/1/2020	62.1	28.1	0.2	9.6	30	0.00
TMP-1S	Weekly	2	12/8/2020	49.0	28.1	0.2	22.7	30	0.00
TMP-1S	Weekly	2	12/11/2020	55.4	27.0	0.2	17.4	30	0.00
TMP-1S	Weekly	2	12/15/2020	51.7	28.3	0.5	19.5	30	0.03
TMP-1S	Weekly	2	12/22/2020	33.7	29.9	0.4	36.0	30	0.01
TMP-1S	Weekly	2	12/29/2020	6.4	19.6	0.8	73.2	30	0.03

Point Name	Frequency	Quadrant	Record Date	CH4 (%)	CO2 (%)	O2 (%)	Balance Gas (%)	Barometric Pressure	Relative Pressure
TMP-2D	Weekly	2	10/6/2020	0.0	0.8	20.6	78.6	30	-0.01
TMP-2D	Weekly	2	10/13/2020	0.0	1.3	21.2	77.5	30	0.01
TMP-2D	Weekly	2	10/20/2020	0.0	1.0	20.7	78.3	30	-0.01
TMP-2D	Weekly	2	10/27/2020	0.0	0.9	20.8	78.3	30	0.00
TMP-2D	Weekly	2	11/3/2020	0.2	0.1	21.0	78.7	30	0.01
TMP-2D	Weekly	2	11/9/2020	0.3	0.2	20.8	78.7	30	-0.34
TMP-2D	Weekly	2	11/17/2020	0.5	0.3	20.8	78.4	30	0.01
TMP-2D	Weekly	2	11/23/2020	1.2	1.0	20.6	77.2	30	0.02
TMP-2D	Weekly	2	12/1/2020	0.6	1.1	20.8	77.5	30	0.04
TMP-2D	Weekly	2	12/8/2020	0.1	0.8	20.9	78.2	30	0.00
TMP-2D	Weekly	2	12/15/2020	0.0	1.3	20.8	77.9	30	0.00
TMP-2D	Weekly	2	12/22/2020	0.0	1.3	20.7	78.0	30	-0.01
TMP-2D	Weekly	2	12/29/2020	0.0	1.2	20.9	77.9	30	-0.01
TMP-2M	Weekly	2	10/6/2020	0.0	4.1	15.2	80.7	30	-0.01
TMP-2M	Weekly	2	10/13/2020	0.0	3.8	15.2	81.0	30	0.00
TMP-2M	Weekly	2	10/20/2020	0.0	2.8	16.1	81.1	30	0.00
TMP-2M	Weekly	2	10/27/2020	0.0	2.6	16.6	80.8	30	0.00
TMP-2M	Weekly	2	11/3/2020	3.4	17.9	0.1	78.6	30	0.01
TMP-2M	Weekly	2	11/9/2020	0.2	4.8	14.0	81.0	30	-0.01
TMP-2M	Weekly	2	11/17/2020	0.0	0.5	19.6	79.9	30	0.01
TMP-2M	Weekly	2	11/23/2020	0.0	1.5	19.9	78.6	30	-0.01
TMP-2M	Weekly	2	12/1/2020	0.0	1.7	20.2	78.1	30	0.00
TMP-2M	Weekly	2	12/8/2020	0.0	2.1	15.9	82.0	30	0.00
TMP-2M	Weekly	2	12/15/2020	0.0	2.6	14.6	82.8	30	0.00
TMP-2M	Weekly	2	12/22/2020	0.0	2.3	16.6	81.1	30	0.00
TMP-2M	Weekly	2	12/29/2020	0.0	1.3	17.5	81.2	30	0.00
TMP-2S	Weekly	2	10/6/2020	0.0	4.0	16.2	79.8	30	-0.01
TMP-2S	Weekly	2	10/13/2020	0.0	2.2	18.5	79.3	30	0.00
TMP-2S	Weekly	2	10/20/2020	0.0	1.6	18.1	80.3	30	-0.01
TMP-2S	Weekly	2	10/27/2020	0.0	2.0	17.8	80.2	30	0.01
TMP-2S	Weekly	2	11/3/2020	0.0	3.3	16.6	80.1	30	0.01
TMP-2S	Weekly	2	11/9/2020	0.0	3.3	16.9	79.8	30	0.00
TMP-2S	Weekly	2	11/17/2020	0.0	0.0	20.0	80.0	30	0.00
TMP-2S	Weekly	2	11/23/2020	0.0	1.3	17.2	81.5	30	0.00
TMP-2S	Weekly	2	12/1/2020	0.0	0.7	18.2	81.1	30	0.00
TMP-2S	Weekly	2	12/8/2020	0.0	0.4	19.2	80.4	30	0.00
TMP-2S	Weekly	2	12/15/2020	0.0	0.6	19.2	80.2	30	0.01
TMP-2S	Weekly	2	12/22/2020	0.0	1.3	18.8	79.9	30	0.00
TMP-2S	Weekly	2	12/29/2020	0.0	0.3	19.8	79.9	30	0.01
TMP-3D	Weekly	2	10/6/2020	0.0	0.9	20.5	78.6	30	0.01

Point Name	Frequency	Quadrant	Record Date	CH4 (%)	CO2 (%)	O2 (%)	Balance Gas (%)	Barometric Pressure	Relative Pressure
TMP-3D	Weekly	2	10/13/2020	0.1	1.3	20.7	77.9	30	0.01
TMP-3D	Weekly	2	10/20/2020	0.0	1.3	20.4	78.3	30	0.01
TMP-3D	Weekly	2	10/27/2020	0.1	1.7	20.6	77.6	30	0.02
TMP-3D	Weekly	2	11/3/2020	0.1	0.5	20.8	78.6	30	0.01
TMP-3D	Weekly	2	11/9/2020	0.0	0.0	19.5	80.5	30	-0.05
TMP-3D	Weekly	2	11/17/2020	0.0	0.6	20.6	78.8	30	-0.04
TMP-3D	Weekly	2	11/23/2020	0.0	0.9	20.5	78.6	30	0.00
TMP-3D	Weekly	2	12/1/2020	0.0	0.5	20.6	78.9	30	-0.07
TMP-3D	Weekly	2	12/8/2020	0.0	0.6	20.6	78.8	30	0.01
TMP-3D	Weekly	2	12/15/2020	0.0	0.5	20.8	78.7	30	-0.05
TMP-3D	Weekly	2	12/22/2020	0.0	0.7	20.8	78.5	30	-0.02
TMP-3D	Weekly	2	12/29/2020	0.0	0.4	21.0	78.6	30	-2.43
TMP-3M	Weekly	2	10/6/2020	0.2	0.6	20.8	78.4	30	-0.04
TMP-3M	Weekly	2	10/13/2020	0.6	2.0	20.7	76.7	30	-0.02
TMP-3M	Weekly	2	10/20/2020	0.7	1.8	20.4	77.1	30	0.00
TMP-3M	Weekly	2	10/27/2020	0.6	2.0	20.9	76.5	30	0.02
TMP-3M	Weekly	2	11/3/2020	0.6	1.2	20.6	77.6	30	-0.01
TMP-3M	Weekly	2	11/9/2020	0.5	1.0	20.5	78.0	30	0.00
TMP-3M	Weekly	2	11/17/2020	0.4	1.1	20.2	78.3	30	-0.05
TMP-3M	Weekly	2	11/23/2020	0.4	0.8	20.6	78.2	30	0.00
TMP-3M	Weekly	2	12/1/2020	0.4	0.4	20.6	78.6	30	0.00
TMP-3M	Weekly	2	12/8/2020	0.3	0.9	20.8	78.0	30	0.01
TMP-3M	Weekly	2	12/15/2020	0.9	0.0	20.5	78.6	30	0.02
TMP-3M	Weekly	2	12/22/2020	0.2	0.5	20.9	78.4	30	0.02
TMP-3M	Weekly	2	12/29/2020	0.6	2.8	21.0	75.6	30	0.01
TMP-3S	Weekly	2	10/6/2020	53.2	41.2	0.0	5.6	30	0.00
TMP-3S	Weekly	2	10/13/2020	51.4	40.1	0.2	8.3	30	0.02
TMP-3S	Weekly	2	10/20/2020	53.1	40.9	0.1	5.9	30	0.01
TMP-3S	Weekly	2	10/27/2020	39.5	27.7	6.8	26.0	30	0.27
TMP-3S	Weekly	2	11/3/2020	31.4	10.0	5.6	53.0	30	0.00
TMP-3S	Weekly	2	11/9/2020	45.4	21.4	0.1	33.1	30	0.01
TMP-3S	Weekly	2	11/17/2020	0.0	0.0	20.9	79.1	30	-9.13
TMP-3S	Weekly	2	11/23/2020	15.0	1.4	9.9	73.7	30	0.47
TMP-3S	Weekly	2	12/1/2020	0.0	0.1	21.0	78.9	30	-3.54
TMP-3S	Weekly	2	12/8/2020	9.9	3.8	6.6	79.7	30	0.00
TMP-3S	Weekly	2	12/11/2020	17.7	10.3	1.1	70.9	30	0.00
TMP-3S	Weekly	2	12/15/2020	0.0	0.0	21.1	78.9	30	0.00
TMP-3S	Weekly	2	12/22/2020	28.1	10.3	1.5	60.1	30	0.01
TMP-3S	Weekly	2	12/29/2020	32.0	9.9	1.5	56.6	30	0.03

TABLE 5

PUBLIC SAFETY GAS MONITORING PROBE DATA

OCTOBER 01, 2020 – DECEMBER 31, 2020

Point Name	Frequency	Quadrant	Record Date	CH4 (%)	CO2 (%)	O2 (%)	Balance Gas (%)	Barometric Pressure	Relative Pressure
4ASS	Weekly	4	10/6/2020	0.1	0.2	20.5	79.2	30	-1.15
4ASS	Weekly	4	10/13/2020	0.0	0.2	20.7	79.1	30	0.04
4ASS	Weekly	4	10/20/2020	0.0	0.2	20.5	79.3	30	0.27
4ASS	Weekly	4	10/27/2020	0.0	0.4	20.8	78.8	30	0.25
4ASS	Weekly	4	11/3/2020	0.0	0.1	20.7	79.2	30	0.05
4ASS	Weekly	4	11/9/2020	0.0	0.1	20.8	79.1	30	-0.03
4ASS	Weekly	4	11/17/2020	0.0	0.1	21.1	78.8	30	-0.14
4ASS	Weekly	4	11/23/2020	0.0	0.6	20.8	78.6	30	0.03
4ASS	Weekly	4	12/1/2020	0.0	0.4	21.0	78.6	30	-0.16
4ASS	Weekly	4	12/8/2020	0.0	0.2	21.0	78.8	30	0.01
4ASS	Weekly	4	12/15/2020	0.0	0.3	21.0	78.7	30	0.02
4ASS	Weekly	4	12/22/2020	0.0	0.2	20.9	78.9	30	0.00
4ASS	Weekly	4	12/29/2020	0.0	0.2	21.0	78.8	30	-0.04
4OSS	Weekly	4	10/6/2020	0.0	0.1	20.6	79.3	30	1.13
4OSS	Weekly	4	10/13/2020	0.0	0.1	20.8	79.1	30	-0.02
4OSS	Weekly	4	10/20/2020	0.0	0.1	20.7	79.2	30	-0.34
4OSS	Weekly	4	10/27/2020	0.0	0.2	21.1	78.7	30	-0.84
4OSS	Weekly	4	11/3/2020	0.0	0.0	20.8	79.2	30	1.08
4OSS	Weekly	4	11/9/2020	0.0	0.0	21.0	79.0	30	-0.02
4OSS	Weekly	4	11/17/2020	0.0	0.0	21.1	78.9	30	-0.12
4OSS	Weekly	4	11/23/2020	0.0	0.1	21.1	78.8	30	0.00
4OSS	Weekly	4	12/1/2020	0.0	0.2	21.0	78.8	30	-1.11
4OSS	Weekly	4	12/8/2020	0.0	0.1	21.1	78.8	30	2.23
4OSS	Weekly	4	12/15/2020	0.0	0.2	20.9	78.9	30	2.45
4OSS	Weekly	4	12/22/2020	0.0	0.2	20.8	79.0	30	2.83
4OSS	Weekly	4	12/29/2020	0.0	0.2	20.9	78.9	30	-3.70
GMP-09	Weekly	2	10/6/2020	0.0	0.5	20.4	79.1	30	-1.33
GMP-09	Weekly	2	10/13/2020	0.0	0.1	20.7	79.2	30	-0.01
GMP-09	Weekly	2	10/20/2020	0.0	0.6	20.4	79.0	30	-2.26
GMP-09	Weekly	2	10/27/2020	0.0	0.6	20.9	78.5	30	-0.04
GMP-09	Weekly	2	11/3/2020	0.0	1.1	20.2	78.7	30	2.96
GMP-09	Weekly	2	11/9/2020	0.0	0.7	20.3	79.0	30	-0.01
GMP-09	Weekly	2	11/17/2020	0.0	0.9	20.6	78.5	30	3.96
GMP-09	Weekly	2	11/23/2020	0.0	0.6	20.8	78.6	30	3.10
GMP-09	Weekly	2	12/1/2020	0.0	0.6	20.7	78.7	30	-0.65
GMP-09	Weekly	2	12/8/2020	0.0	0.4	20.8	78.8	30	-8.91
GMP-09	Weekly	2	12/15/2020	0.0	0.5	20.9	78.6	30	-2.66
GMP-09	Weekly	2	12/22/2020	0.0	0.6	20.6	78.8	30	-3.22
GMP-09	Weekly	2	12/29/2020	0.0	0.5	21.0	78.5	30	-2.82
GMP-10	Weekly	4	10/6/2020	0.0	0.6	17.7	81.7	30	-4.56

Point Name	Frequency	Quadrant	Record Date	CH4 (%)	CO2 (%)	O2 (%)	Balance Gas (%)	Barometric Pressure	Relative Pressure
GMP-10	Weekly	4	10/13/2020	0.0	0.4	17.9	81.7	30	-1.76
GMP-10	Weekly	4	10/20/2020	0.0	0.7	18.9	80.4	30	-0.16
GMP-10	Weekly	4	10/27/2020	0.0	0.7	19.7	79.6	30	-0.08
GMP-10	Weekly	4	11/3/2020	0.0	0.5	20.0	79.5	30	-1.49
GMP-10	Weekly	4	11/9/2020	0.0	0.4	20.1	79.5	30	-2.62
GMP-10	Weekly	4	11/17/2020	0.0	0.7	18.3	81.0	30	-2.17
GMP-10	Weekly	4	11/23/2020	0.0	0.3	18.1	81.6	30	0.52
GMP-10	Weekly	4	12/1/2020	0.0	0.6	18.6	80.8	30	-4.95
GMP-10	Weekly	4	12/8/2020	0.0	0.4	20.0	79.6	30	-4.56
GMP-10	Weekly	4	12/15/2020	0.0	0.4	19.0	80.6	30	-0.01
GMP-10	Weekly	4	12/22/2020	0.0	0.4	19.5	80.1	30	-4.44
GMP-10	Weekly	4	12/29/2020	0.0	0.3	20.3	79.4	30	-2.68
GMP-11	Weekly	4	10/6/2020	0.0	0.0	20.6	79.4	30	-1.27
GMP-11	Weekly	4	10/13/2020	0.0	0.1	20.8	79.1	30	-0.15
GMP-11	Weekly	4	10/20/2020	0.0	0.2	20.4	79.4	30	-0.04
GMP-11	Weekly	4	10/27/2020	0.0	0.3	21.1	78.6	30	0.03
GMP-11	Weekly	4	11/3/2020	0.0	2.2	19.1	78.7	30	-0.17
GMP-11	Weekly	4	11/9/2020	0.0	0.3	20.8	78.9	30	-2.53
GMP-11	Weekly	4	11/17/2020	0.0	2.0	20.2	77.8	30	-0.15
GMP-11	Weekly	4	11/23/2020	0.0	1.1	20.8	78.1	30	1.07
GMP-11	Weekly	4	12/1/2020	0.0	0.8	20.7	78.5	30	0.13
GMP-11	Weekly	4	12/8/2020	0.0	0.2	21.0	78.8	30	-4.69
GMP-11	Weekly	4	12/15/2020	0.0	0.1	20.6	79.3	30	0.15
GMP-11	Weekly	4	12/22/2020	0.0	0.1	21.0	78.9	30	-0.19
GMP-11	Weekly	4	12/29/2020	0.0	0.2	20.8	79.0	30	-0.06
GMP-12	Weekly	4	10/6/2020	0.0	0.1	19.4	80.5	30	-4.69
GMP-12	Weekly	4	10/13/2020	0.0	0.3	19.9	79.8	30	-8.10
GMP-12	Weekly	4	10/20/2020	0.0	0.5	19.9	79.6	30	-3.67
GMP-12	Weekly	4	10/27/2020	0.0	0.5	19.9	79.6	30	-6.16
GMP-12	Weekly	4	11/3/2020	0.0	2.2	18.4	79.4	30	-6.88
GMP-12	Weekly	4	11/9/2020	0.0	1.2	19.7	79.1	30	-5.40
GMP-12	Weekly	4	11/17/2020	0.0	1.7	19.2	79.1	30	-6.05
GMP-12	Weekly	4	11/23/2020	0.0	1.1	19.8	79.1	30	-2.19
GMP-12	Weekly	4	12/1/2020	0.0	0.8	19.5	79.7	30	-3.08
GMP-12	Weekly	4	12/8/2020	0.0	0.3	20.3	79.4	30	-19.54
GMP-12	Weekly	4	12/15/2020	0.0	0.5	20.0	79.5	30	-17.73
GMP-12	Weekly	4	12/22/2020	0.0	0.1	20.4	79.5	30	-16.21
GMP-12	Weekly	4	12/29/2020	0.0	0.3	20.2	79.5	30	-19.54

TABLE 6

GAS MONITORING PROBE WATER LEVEL DATA

OCTOBER 01, 2020 – DECEMBER 31, 2020

Point Name	Date	Quadrant	Depth to Water (ft)	Comments
4AOSS	10/6/2020	4	10.5	No Comment
4AOSS	10/13/2020	4	10.4	No Comment
4AOSS	10/20/2020	4	10.7	No Comment
4AOSS	10/27/2020	4	10.7	No Comment
4AOSS	11/3/2020	4	10.5	No Comment
4AOSS	11/9/2020	4	10.1	No Comment
4AOSS	11/17/2020	4	10.9	No Comment
4AOSS	11/23/2020	4	11.0	No Comment
4AOSS	12/1/2020	4	10.8	No Comment
4AOSS	12/7/2016	4	14.8	No Comment
4AOSS	12/15/2020	4	11.8	No Comment
4AOSS	12/22/2020	4	11.7	No Comment
4AOSS	12/29/2020	4	12.1	No Comment
4ASS	10/6/2020	4	4.7	No Comment
4ASS	10/13/2020	4	5.1	No Comment
4ASS	10/20/2020	4	5.1	No Comment
4ASS	10/27/2020	4	4.7	No Comment
4ASS	11/3/2020	4	4.8	No Comment
4ASS	11/9/2020	4	5.1	No Comment
4ASS	11/17/2020	4	4.9	No Comment
4ASS	11/23/2020	4	4.6	No Comment
4ASS	12/1/2020	4	4.8	No Comment
4ASS	12/7/2016	4	5.0	No Comment
4ASS	12/15/2020	4	4.8	No Comment
4ASS	12/22/2020	4	4.9	No Comment
4ASS	12/29/2020	4	4.8	No Comment
GMP-01	10/6/2020	2	11.8	No Comment
GMP-01	10/13/2020	2	11.8	No Comment
GMP-01	10/20/2020	2	11.8	No Comment
GMP-01	10/27/2020	2	11.8	No Comment
GMP-01	11/3/2020	2	11.8	No Comment

Point Name	Date	Quadrant	Depth to Water (ft)	Comments
GMP-01	11/9/2020	2	11.8	No Comment
GMP-01	11/17/2020	2	11.8	No Comment
GMP-01	11/23/2020	2	11.8	No Comment
GMP-01	12/1/2020	2	11.8	No Comment
GMP-01	12/7/2016	2	11.8	No Comment
GMP-01	12/15/2020	2	11.8	No Comment
GMP-01	12/22/2020	2	11.8	No Comment
GMP-01	12/29/2020	2	11.8	No Comment
GMP-02	10/6/2020	4	9.2	No Comment
GMP-02	10/13/2020	4	9.2	No Comment
GMP-02	10/20/2020	4	9.2	No Comment
GMP-02	10/27/2020	4	9.2	No Comment
GMP-02	11/3/2020	4	9.2	No Comment
GMP-02	11/9/2020	4	9.2	No Comment
GMP-02	11/17/2020	4	9.2	No Comment
GMP-02	11/23/2020	4	9.2	No Comment
GMP-02	12/1/2020	4	9.2	No Comment
GMP-02	12/7/2016	4	9.2	No Comment
GMP-02	12/15/2020	4	9.2	No Comment
GMP-02	12/22/2020	4	9.2	No Comment
GMP-02	12/29/2020	4	9.2	No Comment
GMP-03	10/6/2020	4	18.1	No Comment
GMP-03	10/13/2020	4	18.6	No Comment
GMP-03	10/20/2020	4	18.6	No Comment
GMP-03	10/27/2020	4	12.7	No Comment
GMP-03	11/3/2020	4	18.5	No Comment
GMP-03	11/9/2020	4	19.0	No Comment
GMP-03	11/17/2020	4	18.6	No Comment
GMP-03	11/23/2020	4	18.2	No Comment
GMP-03	12/1/2020	4	18.1	No Comment
GMP-03	12/7/2016	4	18.6	No Comment

Point Name	Date	Quadrant	Depth to Water (ft)	Comments
GMP-03	12/15/2020	4	18.7	No Comment
GMP-03	12/22/2020	4	19.1	No Comment
GMP-03	12/29/2020	4	19.4	No Comment
GMP-05	10/6/2020	3	11.9	No Comment
GMP-06	10/6/2020	1	12.1	No Comment
GMP-07	10/6/2020	1	23.5	No Comment
GMP-08	10/6/2020	1	35.6	No Comment
GMP-08	10/13/2020	1	36.7	No Comment
GMP-08	10/20/2020	1	36.6	No Comment
GMP-08	10/27/2020	1	37.3	No Comment
GMP-08	11/3/2020	1	37.5	No Comment
GMP-08	11/9/2020	1	37.8	No Comment
GMP-08	11/17/2020	1	38.0	No Comment
GMP-08	11/23/2020	1	38.0	No Comment
GMP-08	12/1/2020	1	38.0	No Comment
GMP-08	12/7/2016	1	35.6	No Comment
GMP-08	12/15/2020	1	37.8	No Comment
GMP-08	12/22/2020	1	38.1	No Comment
GMP-08	12/29/2020	1	38.4	No Comment
GMP-09	10/6/2020	2	12.3	No Comment
GMP-09	10/13/2020	2	12.5	No Comment
GMP-09	10/20/2020	2	12.7	No Comment
GMP-09	10/27/2020	2	12.6	No Comment
GMP-09	11/3/2020	2	12.0	No Comment
GMP-09	11/9/2020	2	12.6	No Comment
GMP-09	11/17/2020	2	11.7	No Comment
GMP-09	11/23/2020	2	12.1	No Comment
GMP-09	12/1/2020	2	10.7	No Comment
GMP-09	12/7/2016	2	11.7	No Comment
GMP-09	12/15/2020	2	12.0	No Comment
GMP-09	12/22/2020	2	12.4	No Comment

Point Name	Date	Quadrant	Depth to Water (ft)	Comments
GMP-09	12/29/2020	2	12.7	No Comment
GMP-10	10/6/2020	4	8.7	No Comment
GMP-10	10/13/2020	4	9.0	No Comment
GMP-10	10/20/2020	4	8.7	No Comment
GMP-10	10/27/2020	4	8.6	No Comment
GMP-10	11/3/2020	4	8.6	No Comment
GMP-10	11/9/2020	4	8.9	No Comment
GMP-10	11/17/2020	4	8.6	No Comment
GMP-10	11/23/2020	4	8.2	No Comment
GMP-10	12/1/2020	4	8.3	No Comment
GMP-10	12/7/2016	4	8.9	No Comment
GMP-10	12/15/2020	4	8.5	No Comment
GMP-10	12/22/2020	4	8.8	No Comment
GMP-10	12/29/2020	4	8.8	No Comment
GMP-11	10/6/2020	4	1.1	No Comment
GMP-11	10/13/2020	4	1.4	No Comment
GMP-11	10/20/2020	4	1.3	No Comment
GMP-11	10/27/2020	4	1.3	No Comment
GMP-11	11/3/2020	4	1.0	No Comment
GMP-11	11/9/2020	4	1.4	No Comment
GMP-11	11/17/2020	4	1.4	No Comment
GMP-11	11/23/2020	4	1.2	No Comment
GMP-11	12/1/2020	4	1.4	No Comment
GMP-11	12/7/2016	4	1.3	No Comment
GMP-11	12/15/2020	4	1.3	No Comment
GMP-11	12/22/2020	4	1.5	No Comment
GMP-11	12/29/2020	4	1.6	No Comment
GMP-12	10/6/2020	4	1.4	No Comment
GMP-12	10/13/2020	4	1.8	No Comment
GMP-12	10/20/2020	4	1.3	No Comment
GMP-12	10/27/2020	4	1.3	No Comment

Point Name	Date	Quadrant	Depth to Water (ft)	Comments
GMP-12	11/3/2020	4	1.4	No Comment
GMP-12	11/9/2020	4	1.5	No Comment
GMP-12	11/17/2020	4	1.3	No Comment
GMP-12	11/23/2020	4	1.1	No Comment
GMP-12	12/1/2020	4	1.2	No Comment
GMP-12	12/7/2016	4	1.2	No Comment
GMP-12	12/15/2020	4	1.2	No Comment
GMP-12	12/22/2020	4	1.3	No Comment
GMP-12	12/29/2020	4	1.5	No Comment
GMP-13D	10/6/2020	4	15.6	No Comment
GMP-13D	10/13/2020	4	16.2	No Comment
GMP-13D	10/20/2020	4	16.9	No Comment
GMP-13D	10/27/2020	4	17.4	No Comment
GMP-13D	11/3/2020	4	17.8	No Comment
GMP-13D	11/9/2020	4	18.1	No Comment
GMP-13D	11/17/2020	4	18.4	No Comment
GMP-13D	11/23/2020	4	18.5	No Comment
GMP-13D	12/1/2020	4	18.3	No Comment
GMP-13D	12/7/2016	4	18.2	No Comment
GMP-13D	12/15/2020	4	18.2	No Comment
GMP-13D	12/22/2020	4	18.3	No Comment
GMP-13D	12/29/2020	4	18.4	No Comment
GMP-13S	10/6/2020	4	17.5	No Comment
GMP-13S	10/13/2020	4	18.3	No Comment
GMP-13S	10/20/2020	4	18.7	No Comment
GMP-13S	10/27/2020	4	19.1	No Comment
GMP-13S	11/3/2020	4	19.0	No Comment
GMP-13S	11/9/2020	4	19.4	No Comment
GMP-13S	11/17/2020	4	18.6	No Comment
GMP-13S	11/23/2020	4	16.8	No Comment
GMP-13S	12/1/2020	4	17.5	No Comment

Point Name	Date	Quadrant	Depth to Water (ft)	Comments
GMP-13S	12/7/2016	4	18.3	No Comment
GMP-13S	12/15/2020	4	18.5	No Comment
GMP-13S	12/22/2020	4	19.0	No Comment
GMP-13S	12/29/2020	4	19.6	No Comment
GMP-14D	10/6/2020	3	16.7	No Comment
GMP-14D	10/13/2020	3	17.2	No Comment
GMP-14D	10/20/2020	3	17.6	No Comment
GMP-14D	10/27/2020	3	18.1	No Comment
GMP-14D	11/3/2020	3	18.2	No Comment
GMP-14D	11/9/2020	3	18.5	No Comment
GMP-14D	11/17/2020	3	18.4	No Comment
GMP-14D	11/23/2020	3	17.7	No Comment
GMP-14D	12/1/2020	3	16.3	No Comment
GMP-14D	12/7/2016	3	16.7	No Comment
GMP-14D	12/15/2020	3	17.0	No Comment
GMP-14D	12/22/2020	3	17.2	No Comment
GMP-14D	12/29/2020	3	18.0	No Comment
GMP-14S	10/6/2020	3	14.1	No Comment
GMP-14S	10/13/2020	3	14.7	No Comment
GMP-14S	10/20/2020	3	15.3	No Comment
GMP-14S	10/27/2020	3	15.8	No Comment
GMP-14S	11/3/2020	3	15.9	No Comment
GMP-14S	11/9/2020	3	16.2	No Comment
GMP-14S	11/17/2020	3	14.8	No Comment
GMP-14S	11/23/2020	3	12.9	No Comment
GMP-14S	12/1/2020	3	13.3	No Comment
GMP-14S	12/7/2016	3	14.0	No Comment
GMP-14S	12/15/2020	3	14.0	No Comment
GMP-14S	12/22/2020	3	14.3	No Comment
GMP-14S	12/29/2020	3	15.0	No Comment
GMP-15D	10/6/2020	1	13.1	No Comment

Point Name	Date	Quadrant	Depth to Water (ft)	Comments
GMP-15D	10/13/2020	1	13.7	No Comment
GMP-15D	10/20/2020	1	13.2	No Comment
GMP-15D	10/27/2020	1	12.9	No Comment
GMP-15D	11/3/2020	1	12.5	No Comment
GMP-15D	11/9/2020	1	13.0	No Comment
GMP-15D	11/17/2020	1	12.9	No Comment
GMP-15D	11/23/2020	1	12.3	No Comment
GMP-15D	12/1/2020	1	12.0	No Comment
GMP-15D	12/7/2016	1	12.3	No Comment
GMP-15D	12/15/2020	1	12.3	No Comment
GMP-15D	12/22/2020	1	12.6	No Comment
GMP-15D	12/29/2020	1	13.0	No Comment
GMP-15S	10/6/2020	1	8.4	No Comment
GMP-15S	10/13/2020	1	8.7	No Comment
GMP-15S	10/20/2020	1	8.5	No Comment
GMP-15S	10/27/2020	1	8.1	No Comment
GMP-15S	11/3/2020	1	7.8	No Comment
GMP-15S	11/9/2020	1	8.0	No Comment
GMP-15S	11/17/2020	1	7.5	No Comment
GMP-15S	11/23/2020	1	7.1	No Comment
GMP-15S	12/1/2020	1	7.0	No Comment
GMP-15S	12/7/2016	1	7.2	No Comment
GMP-15S	12/15/2020	1	7.0	No Comment
GMP-15S	12/22/2020	1	7.3	No Comment
GMP-15S	12/29/2020	1	7.4	No Comment
GMP-16D	10/6/2020	1	8.1	No Comment
GMP-16D	10/13/2020	1	8.7	No Comment
GMP-16D	10/20/2020	1	8.3	No Comment
GMP-16D	10/27/2020	1	7.9	No Comment
GMP-16D	11/3/2020	1	7.8	No Comment
GMP-16D	11/9/2020	1	8.2	No Comment

Point Name	Date	Quadrant	Depth to Water (ft)	Comments
GMP-16D	11/17/2020	1	8.2	No Comment
GMP-16D	11/23/2020	1	7.5	No Comment
GMP-16D	12/1/2020	1	7.3	No Comment
GMP-16D	12/7/2016	1	7.6	No Comment
GMP-16D	12/15/2020	1	7.4	No Comment
GMP-16D	12/22/2020	1	8.0	No Comment
GMP-16D	12/29/2020	1	7.8	No Comment
GMP-16S	10/6/2020	1	7.8	No Comment
GMP-16S	10/13/2020	1	7.3	No Comment
GMP-16S	10/20/2020	1	8.0	No Comment
GMP-16S	10/27/2020	1	7.5	No Comment
GMP-16S	11/3/2020	1	7.3	No Comment
GMP-16S	11/9/2020	1	7.9	No Comment
GMP-16S	11/17/2020	1	7.8	No Comment
GMP-16S	11/23/2020	1	7.1	No Comment
GMP-16S	12/1/2020	1	6.8	No Comment
GMP-16S	12/7/2016	1	7.1	No Comment
GMP-16S	12/15/2020	1	7.0	No Comment
GMP-16S	12/22/2020	1	7.6	No Comment
GMP-16S	12/29/2020	1	7.5	No Comment
GMP-4D	10/6/2020	3	16.6	No Comment
GMP-4D	10/13/2020	3	17.4	No Comment
GMP-4D	10/20/2020	3	18.0	No Comment
GMP-4D	10/27/2020	3	18.6	No Comment
GMP-4D	11/3/2020	3	18.6	No Comment
GMP-4D	11/9/2020	3	19.0	No Comment
GMP-4D	11/17/2020	3	18.5	No Comment
GMP-4D	11/23/2020	3	17.7	No Comment
GMP-4D	12/1/2020	3	16.4	No Comment
GMP-4D	12/7/2016	3	17.1	No Comment
GMP-4D	12/15/2020	3	17.5	No Comment

Point Name	Date	Quadrant	Depth to Water (ft)	Comments
GMP-4D	12/22/2020	3	17.8	No Comment
GMP-4D	12/29/2020	3	18.6	No Comment
GMP-4S	10/6/2020	3	16.3	No Comment
GMP-4S	10/13/2020	3	17.2	No Comment
GMP-4S	10/20/2020	3	17.8	No Comment
GMP-4S	10/27/2020	3	18.2	No Comment
GMP-4S	11/3/2020	3	18.3	No Comment
GMP-4S	11/9/2020	3	18.8	No Comment
GMP-4S	11/17/2020	3	18.3	No Comment
GMP-4S	11/23/2020	3	17.0	No Comment
GMP-4S	12/1/2020	3	16.1	No Comment
GMP-4S	12/7/2016	3	16.9	No Comment
GMP-4S	12/15/2020	3	17.2	No Comment
GMP-4S	12/22/2020	3	17.7	No Comment
GMP-4S	12/29/2020	3	18.5	No Comment
GMP-5D	10/6/2020	3	20.4	No Comment
GMP-5D	10/13/2020	3	21.0	No Comment
GMP-5D	10/20/2020	3	20.7	No Comment
GMP-5D	10/27/2020	3	20.4	No Comment
GMP-5D	11/3/2020	3	19.9	No Comment
GMP-5D	11/9/2020	3	20.2	No Comment
GMP-5D	11/17/2020	3	19.9	No Comment
GMP-5D	11/23/2020	3	19.4	No Comment
GMP-5D	12/1/2020	3	19.0	No Comment
GMP-5D	12/7/2016	3	19.2	No Comment
GMP-5D	12/15/2020	3	19.1	No Comment
GMP-5D	12/22/2020	3	19.3	No Comment
GMP-5D	12/29/2020	3	19.6	No Comment
GMP-5S	10/6/2020	3	16.5	No Comment
GMP-5S	10/13/2020	3	16.7	No Comment
GMP-5S	10/20/2020	3	16.9	No Comment

Point Name	Date	Quadrant	Depth to Water (ft)	Comments
GMP-5S	10/27/2020	3	16.5	No Comment
GMP-5S	11/3/2020	3	16.1	No Comment
GMP-5S	11/9/2020	3	16.2	No Comment
GMP-5S	11/17/2020	3	16.0	No Comment
GMP-5S	11/23/2020	3	15.5	No Comment
GMP-5S	12/1/2020	3	15.0	No Comment
GMP-5S	12/7/2016	3	15.2	No Comment
GMP-5S	12/15/2020	3	15.0	No Comment
GMP-5S	12/22/2020	3	15.0	No Comment
GMP-5S	12/29/2020	3	15.5	No Comment
GMP-6D	10/6/2020	1	11.8	No Comment
GMP-6D	10/13/2020	1	12.2	No Comment
GMP-6D	10/20/2020	1	12.1	No Comment
GMP-6D	10/27/2020	1	11.8	No Comment
GMP-6D	11/3/2020	1	11.1	No Comment
GMP-6D	11/9/2020	1	11.4	No Comment
GMP-6D	11/17/2020	1	11.7	No Comment
GMP-6D	11/23/2020	1	10.9	No Comment
GMP-6D	12/1/2020	1	10.4	No Comment
GMP-6D	12/7/2016	1	10.7	No Comment
GMP-6D	12/15/2020	1	10.7	No Comment
GMP-6D	12/22/2020	1	10.9	No Comment
GMP-6D	12/29/2020	1	11.2	No Comment
GMP-6S	10/6/2020	1	8.4	No Comment
GMP-6S	10/13/2020	1	8.8	No Comment
GMP-6S	10/20/2020	1	8.7	No Comment
GMP-6S	10/27/2020	1	7.7	No Comment
GMP-6S	11/3/2020	1	6.6	No Comment
GMP-6S	11/9/2020	1	7.1	No Comment
GMP-6S	11/17/2020	1	6.5	No Comment
GMP-6S	11/23/2020	1	5.9	No Comment

Point Name	Date	Quadrant	Depth to Water (ft)	Comments
GMP-6S	12/1/2020	1	5.7	No Comment
GMP-6S	12/7/2016	1	6.0	No Comment
GMP-6S	12/15/2020	1	5.7	No Comment
GMP-6S	12/22/2020	1	6.0	No Comment
GMP-6S	12/29/2020	1	6.2	No Comment
GMP-7D	10/6/2020	1	19.1	No Comment
GMP-7D	10/13/2020	1	19.6	No Comment
GMP-7D	10/20/2020	1	18.9	No Comment
GMP-7D	10/27/2020	1	18.7	No Comment
GMP-7D	11/3/2020	1	19.1	No Comment
GMP-7D	11/9/2020	1	19.6	No Comment
GMP-7D	11/17/2020	1	19.6	No Comment
GMP-7D	11/23/2020	1	18.8	No Comment
GMP-7D	12/1/2020	1	19.3	No Comment
GMP-7D	12/7/2016	1	19.3	No Comment
GMP-7D	12/15/2020	1	19.4	No Comment
GMP-7D	12/22/2020	1	20.0	No Comment
GMP-7D	12/29/2020	1	20.1	No Comment
GMP-7S	10/6/2020	1	18.2	No Comment
GMP-7S	10/13/2020	1	18.7	No Comment
GMP-7S	10/20/2020	1	17.5	No Comment
GMP-7S	10/27/2020	1	16.8	No Comment
GMP-7S	11/3/2020	1	17.9	No Comment
GMP-7S	11/9/2020	1	18.6	No Comment
GMP-7S	11/17/2020	1	18.1	No Comment
GMP-7S	11/23/2020	1	16.9	No Comment
GMP-7S	12/1/2020	1	18.2	No Comment
GMP-7S	12/7/2016	1	18.4	No Comment
GMP-7S	12/15/2020	1	16.2	No Comment
GMP-7S	12/22/2020	1	19.0	No Comment
GMP-7S	12/29/2020	1	19.1	No Comment

Point Name	Date	Quadrant	Depth to Water (ft)	Comments
TMP-1D	10/6/2020	2	22.2	No Comment
TMP-1D	10/13/2020	2	22.5	No Comment
TMP-1D	10/20/2020	2	22.8	No Comment
TMP-1D	10/27/2020	2	22.7	No Comment
TMP-1D	11/3/2020	2	22.4	No Comment
TMP-1D	11/9/2020	2	22.6	No Comment
TMP-1D	11/17/2020	2	22.3	No Comment
TMP-1D	11/23/2020	2	22.1	No Comment
TMP-1D	12/1/2020	2	21.3	No Comment
TMP-1D	12/7/2016	2	22.3	No Comment
TMP-1D	12/15/2020	2	22.2	No Comment
TMP-1D	12/22/2020	2	22.6	No Comment
TMP-1D	12/29/2020	2	23.0	No Comment
TMP-1M	10/6/2020	2	22.1	No Comment
TMP-1M	10/13/2020	2	22.5	No Comment
TMP-1M	10/20/2020	2	22.8	No Comment
TMP-1M	10/27/2020	2	22.7	No Comment
TMP-1M	11/3/2020	2	22.4	No Comment
TMP-1M	11/9/2020	2	22.6	No Comment
TMP-1M	11/17/2020	2	22.7	No Comment
TMP-1M	11/23/2020	2	22.1	No Comment
TMP-1M	12/1/2020	2	21.7	No Comment
TMP-1M	12/7/2016	2	22.5	No Comment
TMP-1M	12/15/2020	2	22.7	No Comment
TMP-1M	12/22/2020	2	23.1	No Comment
TMP-1M	12/29/2020	2	23.2	No Comment
TMP-1S	10/6/2020	2	21.6	No Comment
TMP-1S	10/13/2020	2	22.0	No Comment
TMP-1S	10/20/2020	2	22.2	No Comment
TMP-1S	10/27/2020	2	22.0	No Comment
TMP-1S	11/3/2020	2	21.6	No Comment

Point Name	Date	Quadrant	Depth to Water (ft)	Comments
TMP-1S	11/9/2020	2	22.0	No Comment
TMP-1S	11/17/2020	2	21.4	No Comment
TMP-1S	11/23/2020	2	20.8	No Comment
TMP-1S	12/1/2020	2	20.3	No Comment
TMP-1S	12/7/2016	2	21.3	No Comment
TMP-1S	12/11/2020	2	21.5	No Comment
TMP-1S	12/15/2020	2	21.4	No Comment
TMP-1S	12/22/2020	2	22.0	No Comment
TMP-1S	12/29/2020	2	22.4	No Comment
TMP-2D	10/6/2020	2	21.7	No Comment
TMP-2D	10/13/2020	2	22.1	No Comment
TMP-2D	10/20/2020	2	22.1	No Comment
TMP-2D	10/27/2020	2	21.4	No Comment
TMP-2D	11/3/2020	2	20.8	No Comment
TMP-2D	11/9/2020	2	21.6	No Comment
TMP-2D	11/17/2020	2	20.4	No Comment
TMP-2D	11/23/2020	2	19.6	No Comment
TMP-2D	12/1/2020	2	19.5	No Comment
TMP-2D	12/7/2016	2	21.1	No Comment
TMP-2D	12/15/2020	2	21.1	No Comment
TMP-2D	12/22/2020	2	21.8	No Comment
TMP-2D	12/29/2020	2	22.3	No Comment
TMP-2M	10/6/2020	2	21.6	No Comment
TMP-2M	10/13/2020	2	21.7	No Comment
TMP-2M	10/20/2020	2	21.9	No Comment
TMP-2M	10/27/2020	2	21.2	No Comment
TMP-2M	11/3/2020	2	20.7	No Comment
TMP-2M	11/9/2020	2	21.1	No Comment
TMP-2M	11/17/2020	2	20.2	No Comment
TMP-2M	11/23/2020	2	19.6	No Comment
TMP-2M	12/1/2020	2	19.5	No Comment

Point Name	Date	Quadrant	Depth to Water (ft)	Comments
TMP-2M	12/7/2016	2	20.9	No Comment
TMP-2M	12/15/2020	2	21.0	No Comment
TMP-2M	12/22/2020	2	20.6	No Comment
TMP-2M	12/29/2020	2	21.2	No Comment
TMP-2S	10/6/2020	2	17.5	No Comment
TMP-2S	10/13/2020	2	17.5	No Comment
TMP-2S	10/20/2020	2	17.5	No Comment
TMP-2S	10/27/2020	2	17.5	No Comment
TMP-2S	11/3/2020	2	17.5	No Comment
TMP-2S	11/9/2020	2	17.5	No Comment
TMP-2S	11/17/2020	2	17.4	No Comment
TMP-2S	11/23/2020	2	17.4	No Comment
TMP-2S	12/1/2020	2	17.4	No Comment
TMP-2S	12/7/2016	2	17.4	No Comment
TMP-2S	12/15/2020	2	17.4	No Comment
TMP-2S	12/22/2020	2	17.5	No Comment
TMP-2S	12/29/2020	2	17.4	No Comment
TMP-3D	10/6/2020	2	21.0	No Comment
TMP-3D	10/13/2020	2	21.5	No Comment
TMP-3D	10/20/2020	2	21.5	No Comment
TMP-3D	10/27/2020	2	20.9	No Comment
TMP-3D	11/3/2020	2	20.3	No Comment
TMP-3D	11/9/2020	2	21.0	No Comment
TMP-3D	11/17/2020	2	20.8	No Comment
TMP-3D	11/23/2020	2	20.1	No Comment
TMP-3D	12/1/2020	2	20.0	No Comment
TMP-3D	12/7/2016	2	21.0	No Comment
TMP-3D	12/15/2020	2	21.1	No Comment
TMP-3D	12/22/2020	2	21.0	No Comment
TMP-3D	12/29/2020	2	22.0	No Comment
TMP-3M	10/6/2020	2	21.5	No Comment

Point Name	Date	Quadrant	Depth to Water (ft)	Comments
TMP-3M	10/13/2020	2	21.8	No Comment
TMP-3M	10/20/2020	2	21.9	No Comment
TMP-3M	10/27/2020	2	21.3	No Comment
TMP-3M	11/3/2020	2	20.8	No Comment
TMP-3M	11/9/2020	2	21.3	No Comment
TMP-3M	11/17/2020	2	20.7	No Comment
TMP-3M	11/23/2020	2	20.4	No Comment
TMP-3M	12/1/2020	2	20.2	No Comment
TMP-3M	12/7/2016	2	21.2	No Comment
TMP-3M	12/15/2020	2	21.4	No Comment
TMP-3M	12/22/2020	2	21.1	No Comment
TMP-3M	12/29/2020	2	22.3	No Comment
TMP-3S	10/6/2020	2	22.8	No Comment
TMP-3S	10/13/2020	2	23.0	No Comment
TMP-3S	10/20/2020	2	23.2	No Comment
TMP-3S	10/27/2020	2	20.9	No Comment
TMP-3S	11/3/2020	2	22.0	No Comment
TMP-3S	11/9/2020	2	22.8	No Comment
TMP-3S	11/17/2020	2	18.7	No Comment
TMP-3S	11/23/2020	2	18.7	No Comment
TMP-3S	12/1/2020	2	20.2	No Comment
TMP-3S	12/7/2016	2	22.0	No Comment
TMP-3S	12/11/2020	2	22.3	No Comment
TMP-3S	12/15/2020	2	21.3	No Comment
TMP-3S	12/22/2020	2	22.8	No Comment
TMP-3S	12/29/2020	2	23.4	No Comment

APPENDIX A

LANDFILL GAS CORRECTIVE ACTION PLAN UPDATE, JULY 26, 2013

**BRIDGETON LANDFILL
LANDFILL GAS CORRECTIVE ACTION PLAN UPDATE**

**Submitted Pursuant to Section 23 of Agreed Order
Case No. 13SL-CC01088, Effective May 13, 2013**

**Bridgeton Landfill, LLC
13570 St. Charles Rock Rd.
Bridgeton, MO 63044**

Technical Contributors:

Civil & Environmental Consultants, Inc.
4848 Park 370, Suite F
Hazelwood, MO 63042

Weaver Boos Consultants
1000 N. College Ave., Suite D
Columbia, MO 65201

July 26, 2013

TABLE OF CONTENTS

1.0 INTRODUCTION..... 1
2.0 REVIEW OF CURRENT GAS MIGRATION CONTROL STATUS 2
3.0 RECENT GAS MIGRATION CONTROL EFFORTS 5
4.0 PROPOSED AND ONGOING GAS MIGRATION CONTROL EFFORTS 7
5.0 CONTINUED MONITORING AND REPORTING..... 9

TABLES

- Table 1: Compliance Gas Monitoring Probe Data (11/21/12 – 7/5/13)
- Table 2: Sentry Gas Monitoring Probe Data (11/21/12 – 7/5/13)
- Table 3: Temporary Gas Monitoring Probe Data (11/21/12 – 7/5/13)
- Table 4: Public Safety Gas Monitoring Probe Data (11/21/12 – 7/5/13)

APPENDICES

- Appendix A – Gas Monitoring Probe Methane Level Graphs
- Appendix B – GMP and TMP Boring Logs/Construction Logs
- Appendix C – Bridgeton Landfill Infrastructure As-Built Drawing, July 2013

1.0 INTRODUCTION

On May 13, 2013, Bridgeton Landfill entered into an Agreed Order with the State of Missouri which requires actions to address what was called a subsurface smoldering event (SSE). Section 23 of the Agreed Order requires the preparation of an updated "Landfill Gas Corrective Action Plan" (CAP) and requests that the update consider SSE control measures.

Missouri Solid Waste Management Regulations require that subsurface landfill gas be controlled so that it does not exceed 2.5% (which is equal to 50% of the lower explosive limit, or LEL) in the ground at the facility property boundary. If this level is exceeded at the property boundary, the facility must implement enhanced monitoring and corrective measures. Corrective Action Plans are frequently used to present and communicate these measures.

Bridgeton Landfill has been monitoring for gas migration using permanent gas monitoring probes since 1998. Since that time, landfill gas Corrective Action Plans have been implemented, additional monitoring locations have been added, and many control features have been installed. These efforts have been previously documented and are incorporated by reference as background for this current work.

Lateral landfill gas migration is common at unlined municipal solid waste (MSW) landfills, and especially in quarry fill environments. Bridgeton Landfill has some areas where the property line is close to solid waste limits (near the edge of the quarry wall) and monitoring has detected methane near the property line in certain locations. In addition, the SSE that Bridgeton Landfill has been experiencing since 2010, and that intensified in 2012, has further challenged methane control in those areas.

The purpose of this document, as required by the Agreed Order, is to provide an update to the November 27, 2012 CAP that considers the SSE control measures. As such, this document includes monitoring data up to July 2013, reviews the status of gas migration control, presents recent (since the approved November 27, 2012 CAP) efforts to reduce methane migration, and discusses forward-going monitoring and reporting procedures. It is intended that this CAP supplements and/or supersedes the previous CAPs and agreements.

2.0 REVIEW OF CURRENT GAS MIGRATION CONTROL STATUS

The intensification of the SSE has created conditions that have made control of gas migration more challenging, including:

- Increased pressure within the landfill waste with pressure-gradient which forces gas outward;
- Increased liquid generation resulting in steam and saturated gas which effects collection efficiency, and
- Carefully controlled and reduced application of gas extraction well vacuum with efforts to minimize oxygen content in the gas well.

Detailed graphs showing methane concentrations for the past three years are included in Appendix A. Appendix B includes a list of the gas monitoring probes monitored at the Bridgeton Landfill along with the boring logs and/or construction logs for each probe. Please note, the gas monitoring probes has been referenced with different abbreviations and the table in Appendix B is included to provide clarity.

As can be seen on the graphs, there are several compliance point and sentry monitoring probe locations that have been historically elevated (GMP-01, GMP-04, GMP-05 GMP-06 and GMP-07), as well as elevated levels in new gas monitoring probes where monitoring began in October 2012 after the SSE intensified (GMP-5S, GMP-14S, GMP-14D). Temporary monitoring probes installed to determine the rate and extent of the methane migration in the vicinity of impacted probe GMP-01 (TMP-1S, TMP-2S, TMP-2M, TMP-2D, TMP-3S, TMP-3M, and TMP-3D) have also exhibited elevated levels of methane since installation.

Due to the additional gas monitoring probes, which initiated monitoring in October 2012 to better define the zone of migration on the eastern boundary of the landfill, GMP-04 through GMP-07 located closer to the landfill are typically monitored on a quarterly basis but are sentry probes and are no longer utilized as the compliance probes in accordance with Missouri Solid Waste Law and Rules. Tables 1 through 4 present the probe results for the monitoring period November 21, 2012 through July 5, 2013.

Along the southern boundary of the landfill, adjacent to Boenker Road, GMP-01 has continued to show elevated levels above the regulatory threshold. Corrective measures have not been effective to address the migration in this vicinity. Corrective actions taken to date have focused on methane migration within the soil overburden due to investigative action demonstrating shallow migration. However, after the installation of the interceptor trench, which was constructed to the soil/bedrock interface between the waste disposal area and impacted GMP-01, elevated levels continued to be exhibited in GMP-01. Due to the ineffectiveness of the perimeter gas wells (2005) and interceptor trench (2010) installed in the vicinity of GMP-01 to eliminate or reduce methane impacts, further investigation was deemed necessary under the conditions of the Settlement Agreement.

In order to effectively determine the zone of migration in the vicinity of GMP-01, temporary probes (TMP-1, TMP-2 and TMP-3) were installed as investigation probes to better define the zone of migration. In order to do this, each temporary probe were installed as nested probes with three monitored zones – shallow (S), middle (M) and deep (D). The shallow zone was screened within the soil overburden; the middle zone was screened through the uppermost weathered/fractured bedrock and the deep zone within the saturated bedrock. As presented in Appendix A, TMP-1 located west of GMP-01 is impacted with elevated methane levels within the soil overburden and weathered bedrock. TMP-2, located east of GMP-01, and TMP-3, located north of GMP-01, has observed elevated methane in each of the monitored zones. It is likely the observed elevated methane within the deep monitored zone observed in TMP-2 and TMP-3 are a result of diffusion transport due to these probes located less than 75 feet from the waste mass as well as the pressure-gradient force caused by the SSE as noted with increased relative pressure during monitoring of the probes.

As noted in the TMP boring logs, weathered bedrock was observed at lower elevations than the base of the interceptor trench. TMP-1, located west of GMP-1, the weathered bedrock was observed between 36 feet below ground surface (bgs) to 66.5 feet bgs. TMP-2, located east of GMP-1, the weathered bedrock was observed between 18 feet bgs to 47 feet bgs. TMP-3, located between the landfill and GMP-1, the weathered bedrock was observed between 31 feet bgs to 50 feet bgs. TMP-2, located between the landfill and GMP-1, the weathered bedrock was observed between 31 feet bgs to 50 feet bgs. Due to weathered bedrock observed at lower elevations than the base of the interceptor trench, it is likely methane continues to migrate through these weathered zones. Table 3 presents the temporary gas monitoring probe data.

The intensification of the SSE in 2012, resulting in increased pressure within the landfill, brought challenges associated within dewatering the interceptor trench located south of the waste boundary and maintaining sufficient vacuum on select gas extraction wells located within the south quarry. As a result, elevated levels of methane continue to be observed since October 2012.

Currently the public safety probes located across Boenker Road, on private property (GMP-09, GMP-10, GMP-11, and GMP-12) have no detectable levels of methane and have not observed elevated methane in two years (GMP-11). There is no evidence of methane migration onto adjacent properties at this time. Table 4 presents the gas monitoring probe data for the public safety probes.

Along the east property boundary, adjacent to the south quarry, elevated methane has been observed at two gas monitoring probe locations utilized for compliance: GMP-5S, GMP-14S, GMP-14D. The gas monitoring probes installed between August and September 2012 were installed as nested probes with two monitoring zones - shallow (S) and deep (D). The shallow zone was screened within the soil overburden; the deep zone was screened through the uppermost weathered bedrock to approximately 10 feet below the historic low water table.

The intent of these nested probes is to determine if methane migration is occurring at the property boundary as well as to ascertain the zone in which it is occurring. Similar to GMP-01, weathered bedrock was observed below the soil overburden at GMP-14 where GMP-14D is screened. The weathered bedrock is likely providing a zone of migration within the deeper zone, GMP-14D.

As described in Section 3.0, Bridgeton Landfill has performed recent improvements that should ultimately reduce landfill gas migration.

3.0 RECENT GAS MIGRATION CONTROL EFFORTS

Many recent additional measures have been recently undertaken that should ultimately reduce gas migration, including:

1. The SSE has impacted the facility's infrastructure designed to remove liquid efficiently from the waste mass which results in increased liquid in the force main and the gas conveyance system resulting in a reduction of their efficiency to remove landfill gas. Adding new gas extraction wells, replacing compromised gas extraction wells, and adding liquid pumps and extraction points will improve landfill gas collection and improve overall efficiency of the system. The following features have been installed per the November 27, 2012 CAP and in addition to the measures proposed in the CAP:
 - In November 2012 the Bridgeton Landfill installed 5 new trench wells, 5 new liquid sumps, and 7 new gas extraction wells.
 - During the January 1, 2013 through June 30, 2013 period the following additional extraction points were installed at the Bridgeton Landfill:
 - In February 2013 the Bridgeton Landfill installed 9 new gas extraction wells,
 - In March 2013 the Bridgeton Landfill installed 3 new gas extraction wells,
 - In April 2013 the Bridgeton Landfill installed 11 new gas extraction wells,
 - In May 2013 the Bridgeton Landfill installed 13 new gas extraction wells,
2. Addition of a 2,500 scfm utility flare in the southeastern portion of the disposal area in June 2013. This flare has improved vacuum distribution around the well field, especially in the southern and southeastern end where migration has been problematic.
3. Installation of 25 perimeter liquid sumps connected by perforated liquid/gas collection piping in May and June 2013. These were installed as part of the South Quarry capping project, and will allow collection of additional gas at the perimeter of the landfill, and
4. Placement of 32 acres of geomembrane cap and enhanced gas collection features which should be completed in August 2013. The cap will allow additional vacuum to be pulled from the cover integrity system consisting of a composite liner system which will reduce concern for oxygen intrusion. This should result in better long term gas capture and, in time, reduced gas pressure.

An updated as-built map that shows all of these features that were in place as of June 30, 2013 is included in Appendix C.

Due to the increased liquid generation and increased pressure within the landfill the improvements completed within the past nine months have not yet resulted in a reduction of methane observed within the gas monitoring probes. It is premature to evaluate the

effectiveness of the recent gas migration control efforts outlined in this section due to impacts associated with increased liquid generation and the continued dynamic movement and changes of the SSE in the South Quarry area.

4.0 PROPOSED AND ONGOING GAS MIGRATION CONTROL EFFORTS

The recent additional measures outlined in Section 3.0 are on-going efforts to improve landfill gas control at the Bridgeton Landfill. These upgrades should reduce pressure within the waste mass that may be contributing to the exceedances and in turn alleviate methane migration along the southern and eastern property boundaries. Improvements to the landfill are on-going and will continue until the SSE is controlled. Below are additional improvements that are being proposed or currently implemented:

1. The SSE has resulted in an increase in condensate generation. In order to improve liquid removal at the site a third party consultant has been contracted to evaluate the effectiveness of the existing force main. Due to the increased liquid movement within the force main pressure has built up within the system resulting in back pressure and reduced pump functionality. Pressure relief valves have been installed on numerous pneumatic pumps to address this issue. However, due to the increased liquid generation additional capacity within the force main is needed. As such, the preliminary design proposes utilizing the existing force main for management of liquid removed from the LCSs and a second separate force main for liquids removed from the remaining extraction points. The additional liquid force main will allow optimum operations of the pumps while providing increased available vacuum on the landfill gas collection system. This corrective action measure will be submitted to the MDNR in third quarter 2013 sealed by a Missouri Professional Engineer.
2. In order to improve liquid management once the liquids are removed from the disposal area the Bridgeton Landfill has contracted with a third party consulting firm for additional storage and pretreatment of the extracted liquid. During the second quarter 2013 the landfill installed a 316,000 gallon above ground liquid storage and treatment tank. The preliminary treatment plant design includes incorporation of the existing 96,000 gallon tank located near Boenker Road, the newly installed 316,000 gallon tank, four-1,000,000 gallon tanks and a pretreatment facility. This will provide the landfill additional capacity to remove the liquid from the disposal area at a design capacity of 300,000 gallons per day. The treatment plant design will be submitted to the MDNR in third quarter 2013 sealed by a Missouri Professional Engineer.
3. The Bridgeton Landfill has submitted a Permit to Construct application to the St. Louis County Department of Health for the installation of two 4,000 scfm utility flares. These utility flares would replace the existing enclosed flares with a design flow of 3,500 scfm each. The replacement of the enclosed flares with the two 4,000 scfm utility flares coupled with the existing 3,500 scfm John Zink utility flare and the 2,500 scfm LFG Specialties utility flare will provide a combined design flow of the four utility flares of 14,000 scfm. Authorization to Construct is anticipated to be issued by the end of July 2013. The installation of the 4,000 scfm utility flares is anticipated to be completed shortly after permit issuance with operations of each unit by the end of third quarter

2013. Utility flares are better suited to handle the lower heating value gas at the Bridgeton Landfill resulting in less downtime of the control devices.

4. A natural gas line has been installed in the vicinity of the flare compound. It will be connected to the gas collection system if the lower heating value or hydrogen concentration drop below levels to effectively operate the landfill gas control devices.
5. The Bridgeton Landfill will be upgrading the landfill gas coolers at the east utility flare (2,500 scfm LFG Specialties) and at the flare compound in the near future. This improvement will result in additional vacuum available to the well field.

The improvements associated with the liquid conveyance system and the landfill gas control devices are essential to address methane migration at the facility. These efforts should result in a decrease in pressure within the landfill and improved landfill gas collection efficiencies within the south quarry. The liquid force main modification and the liquid treatment system will be submitted to the MDNR for review and approval. The landfill appreciates the continued support to address the SSE in a timely manner and appreciates an expedited review of these submittals.

Monitoring results of the nested gas and temporary monitoring probes have shown that methane is migrating through the weathered bedrock and additional controls are likely needed to address these exceedances. However, due to increased liquid generation associated with the SSE, the effectiveness of the recent improvements could not be determined. It is requested to further evaluate the zone of migration of the impacted gas monitoring and temporary monitoring probes with weekly water level readings and monitoring of the impacted probes to better delineate if methane is migrating through deeper zones. It is requested that this evaluation period be extended through the third quarter 2013. At that time a comprehensive corrective action plan will be submitted evaluating the impact of the recently-completed capping, other recent measures, and the proposed measures described above. During this period the landfill will continue to complete improvements to the liquid conveyance system in efforts to minimize liquids within the gas collection system.

5.0 CONTINUED MONITORING AND REPORTING

The Bridgeton Landfill will initiate weekly monitoring of all monitoring probes including the gas monitoring probes, sentry probes and temporary monitoring probes. The Bridgeton Landfill proposes that landfill gas corrective summary reports to be incorporated into the quarterly report and submitted by the 15th of each month following a calendar quarter. These reports will summarize all corrective action completed to address methane migration within the prior quarter and, if elevated levels persist, provide a corrective action plan to address the methane exceedances.

Bridgeton Landfill understands that the submittal of quarterly landfill gas corrective action summary reports and corrective action plans is at a higher frequency than outlined in Paragraph 4 of the January 17, 2011 Settlement Agreement between the MDNR and the Bridgeton Landfill but believes that incorporation in the quarterly report is valuable.

This section of the report will include at a minimum a review previous data, evaluate effectiveness of efforts made to control migration, and propose additional measures directed at eliminating detection levels in gas monitoring probes. As a regular procedure, these reports will be submitted by the 15th of each month following a calendar quarter.

Bridgeton Landfill will continue to take aggressive action to control the impacts of the SSE, evaluate corrective measures to address methane migration within the weathered bedrock and improve gas collection within the limits of waste. Any major new gas migration control features needed--particularly those located outside the limit of waste--would be designed and sealed by a Missouri professional engineer and submitted to the MDNR for comment and approval.

The MDNR will continue to provide ongoing review, comment, and approval of actions as it deems necessary. This reporting process will continue until Bridgeton Landfill demonstrates uninterrupted compliance with the MDNR's methane regulations (all compliance gas monitoring probes less than 2.5% methane) for a period of one year.

APPENDIX B

GAS MONITORING PROBE METHANE LEVEL GRAPHS

Southern and Western Compliance Probes

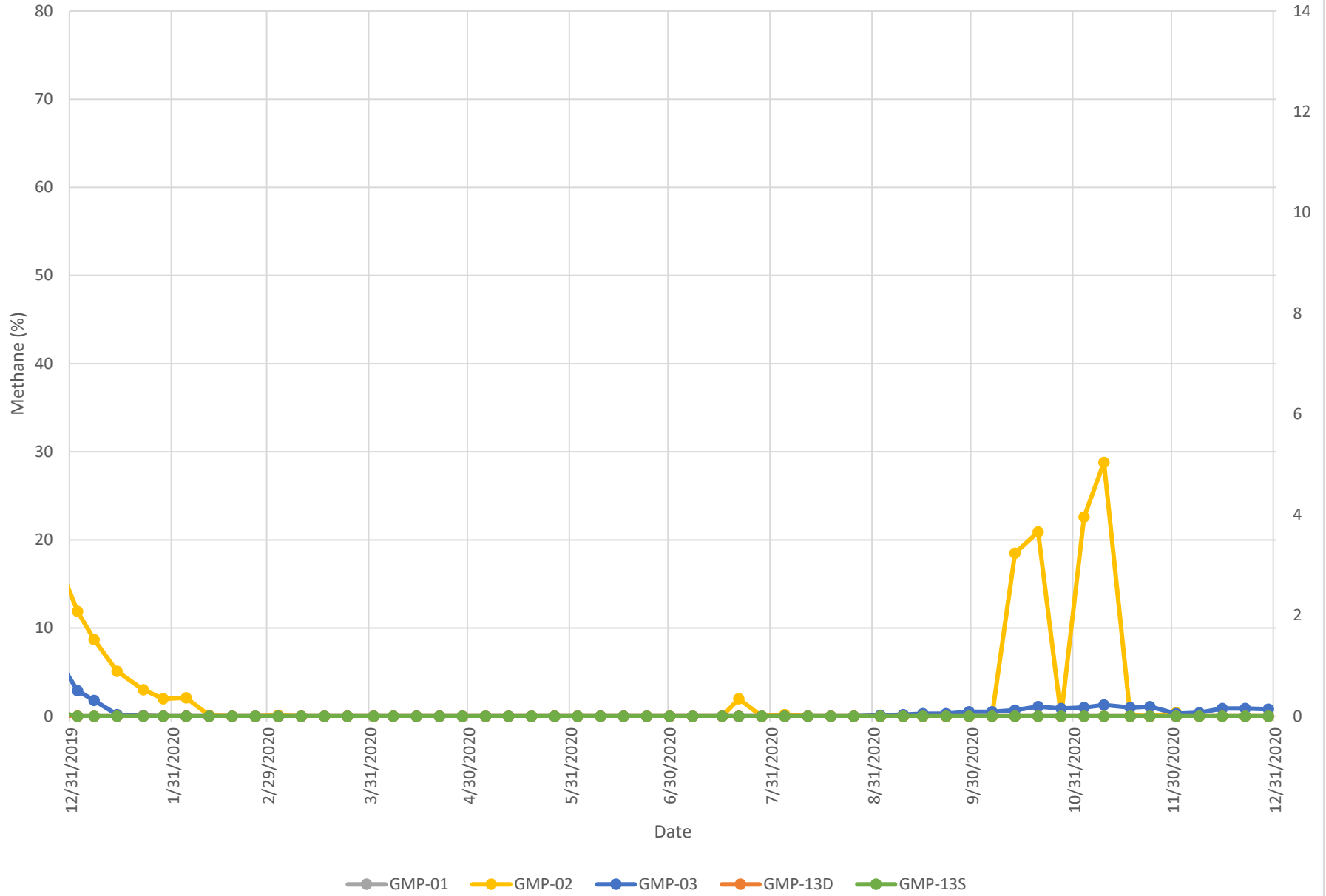

Eastern Compliance Probes

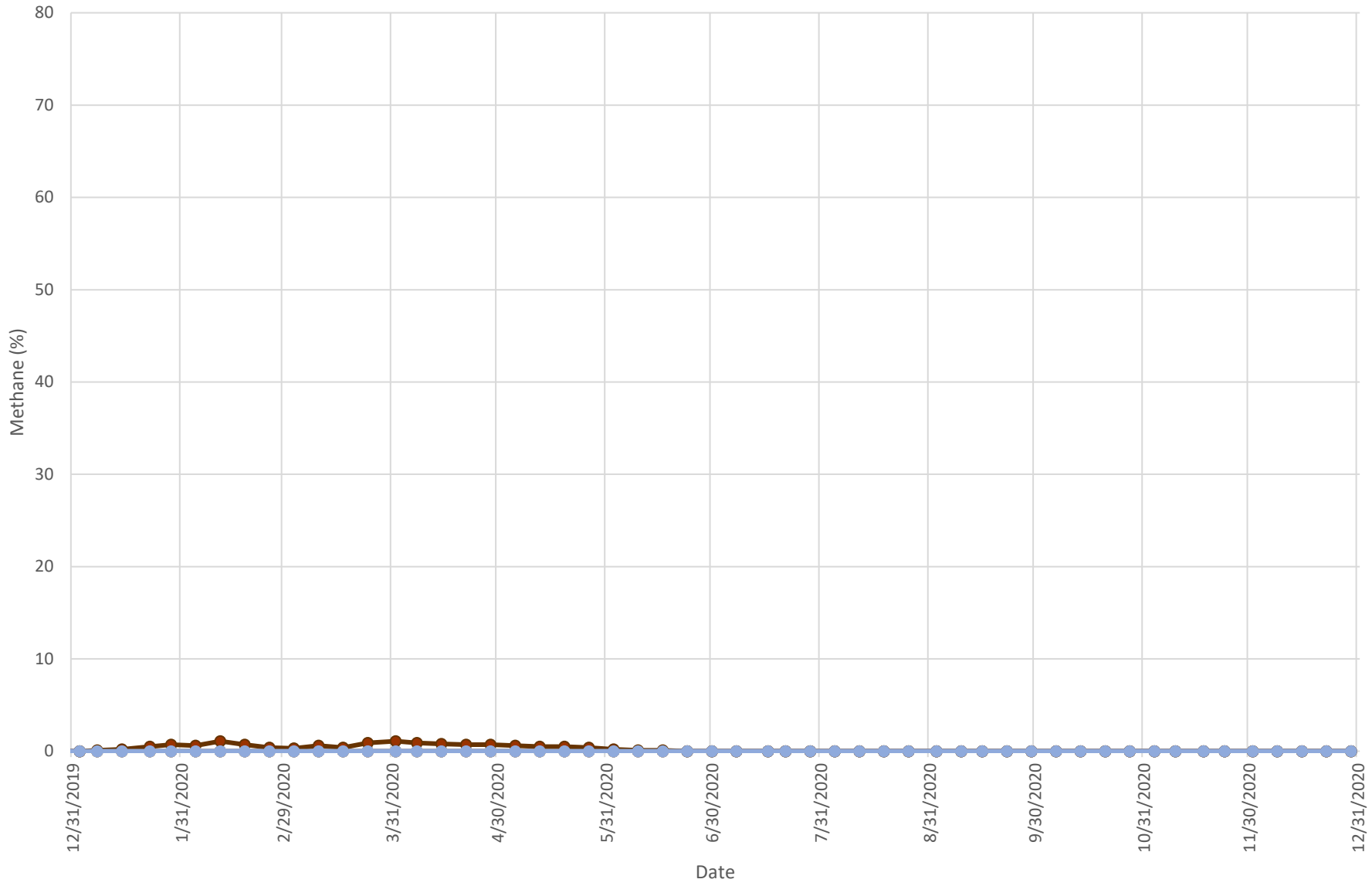

Legend: GMP-4D (yellow), GMP-4S (dark blue), GMP-5D (green), GMP-5S (purple), GMP-6D (orange), GMP-6S (grey), GMP-14D (brown), GMP-14S (light blue)

North Compliance Probes

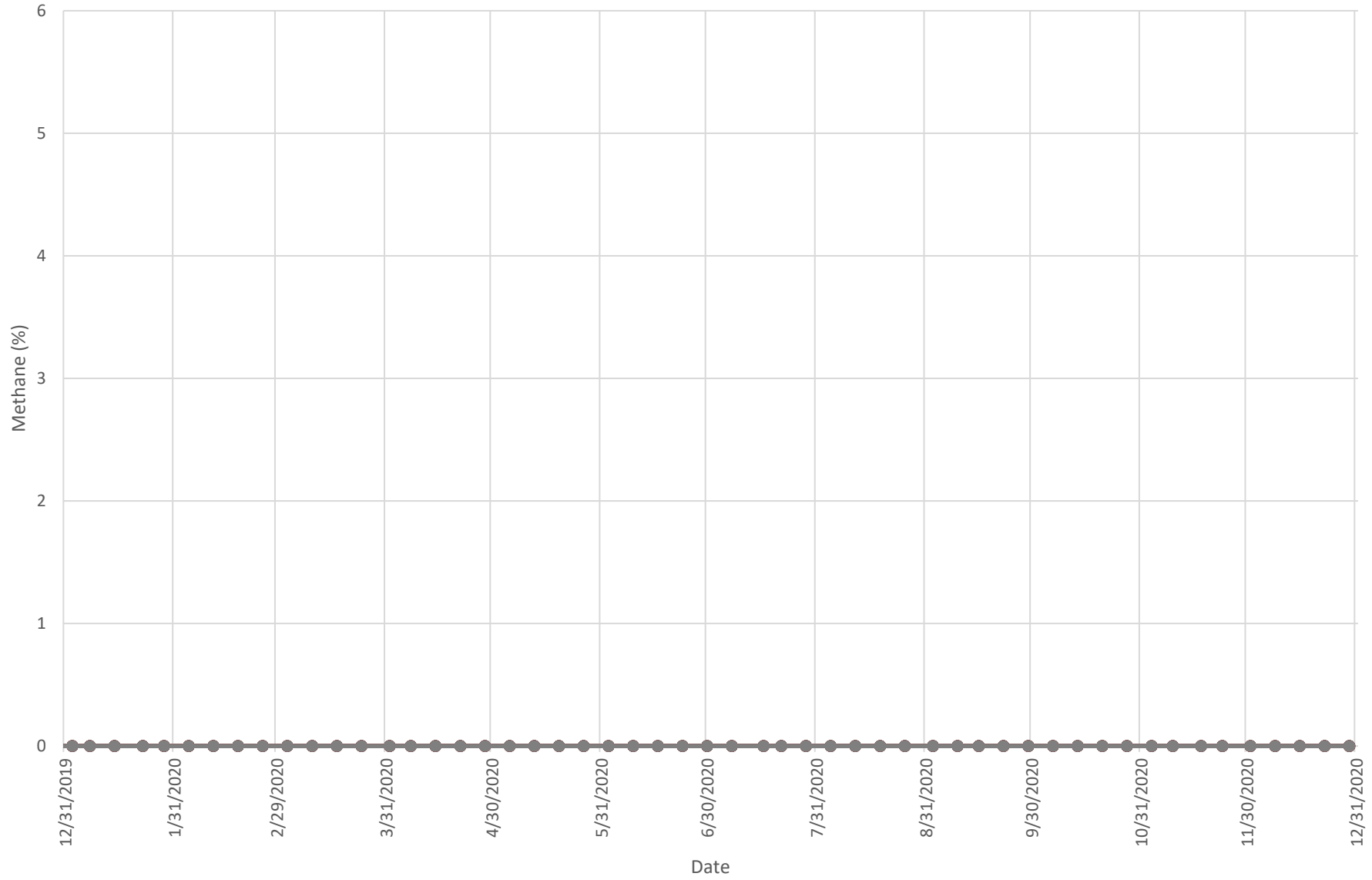

Legend: GMP-7D (Yellow), GMP-7S (Light Blue), GMP-08 (Black), GMP-15D (Green), GMP-15S (Blue), GMP-16D (Red), GMP-16S (Grey)

Sentry Probes

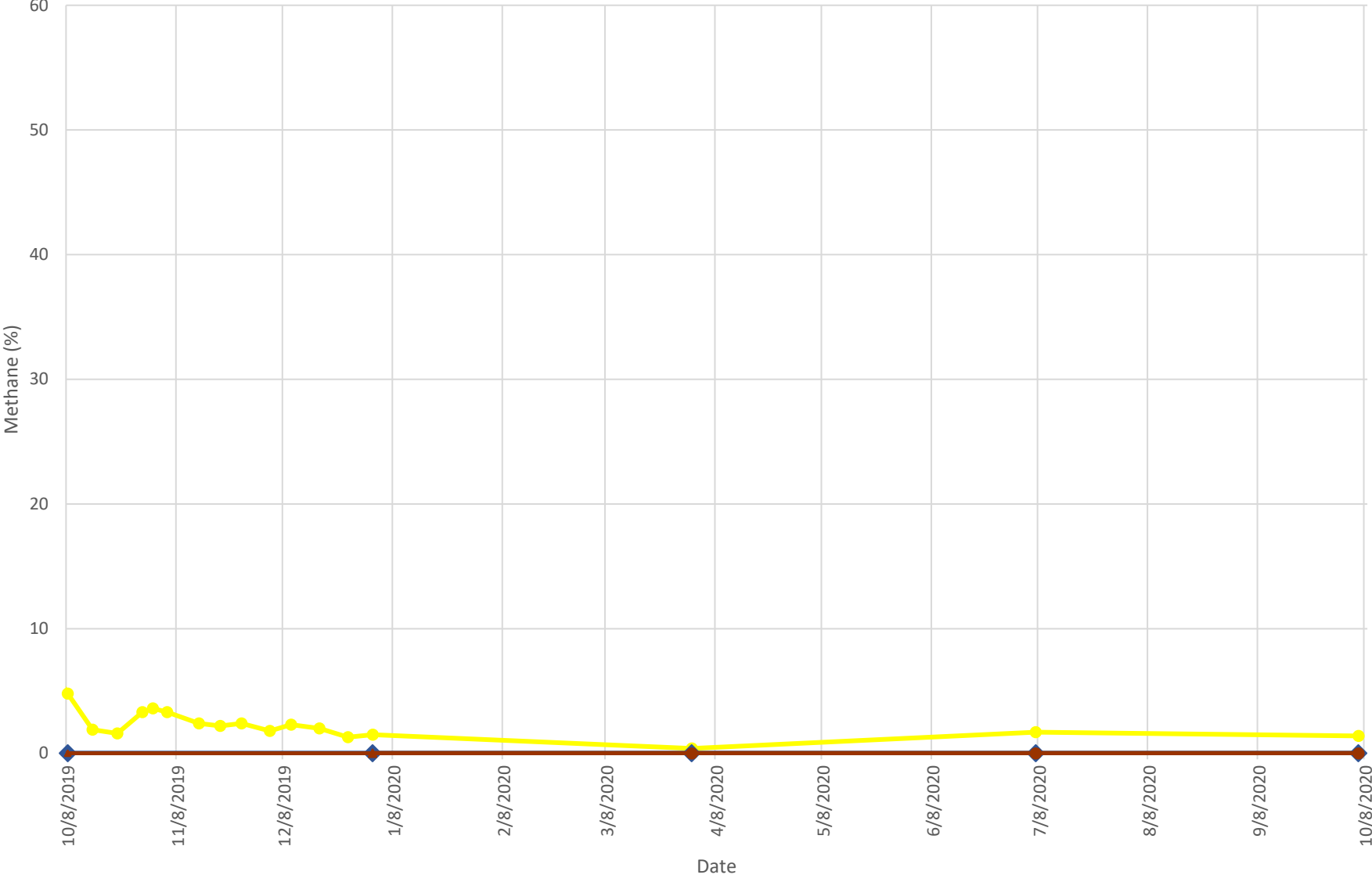

—●— GMP-05 —◆— GMP-06 —●— GMP-07

Shallow Investigative Probes

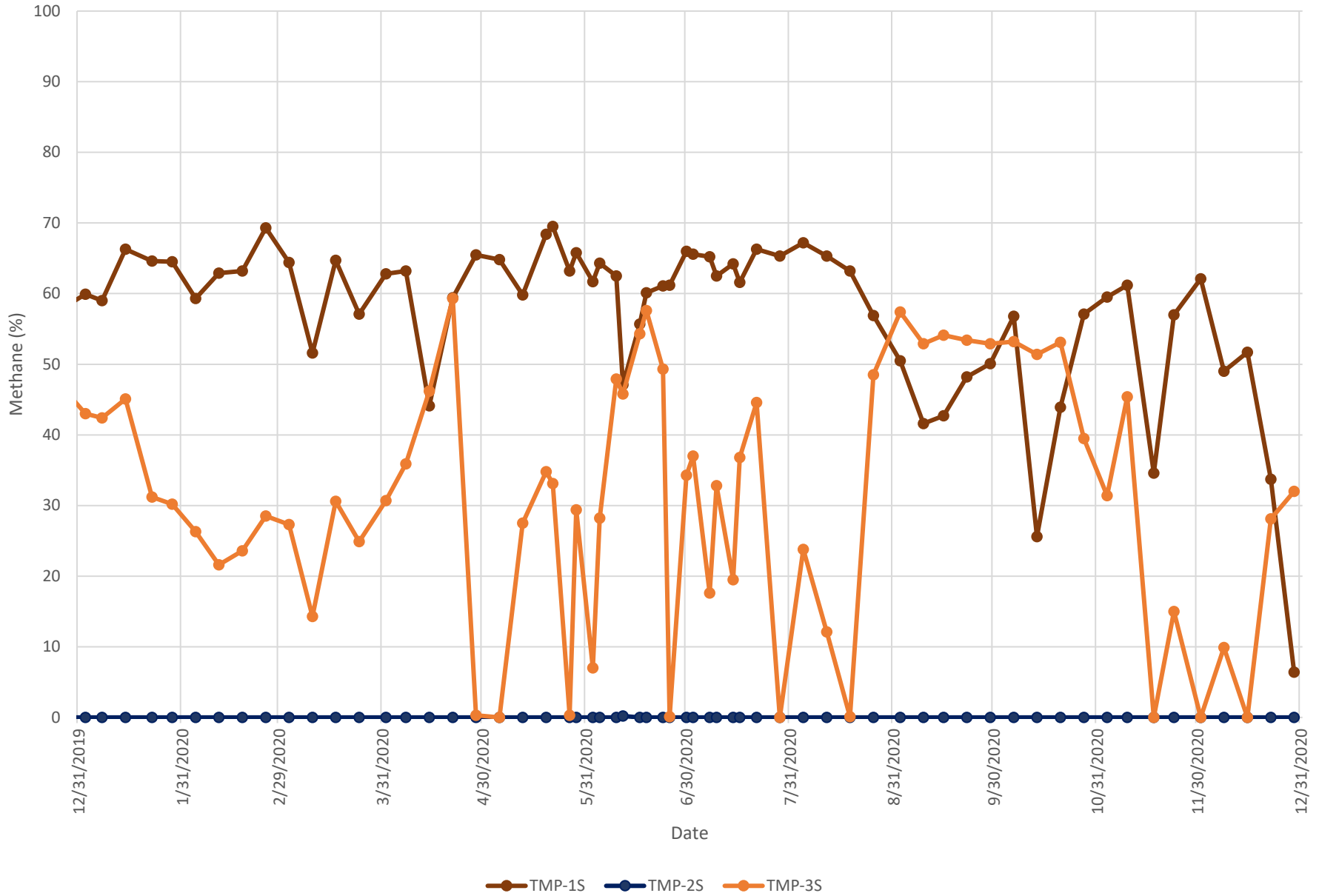

Mid Investigative Probes

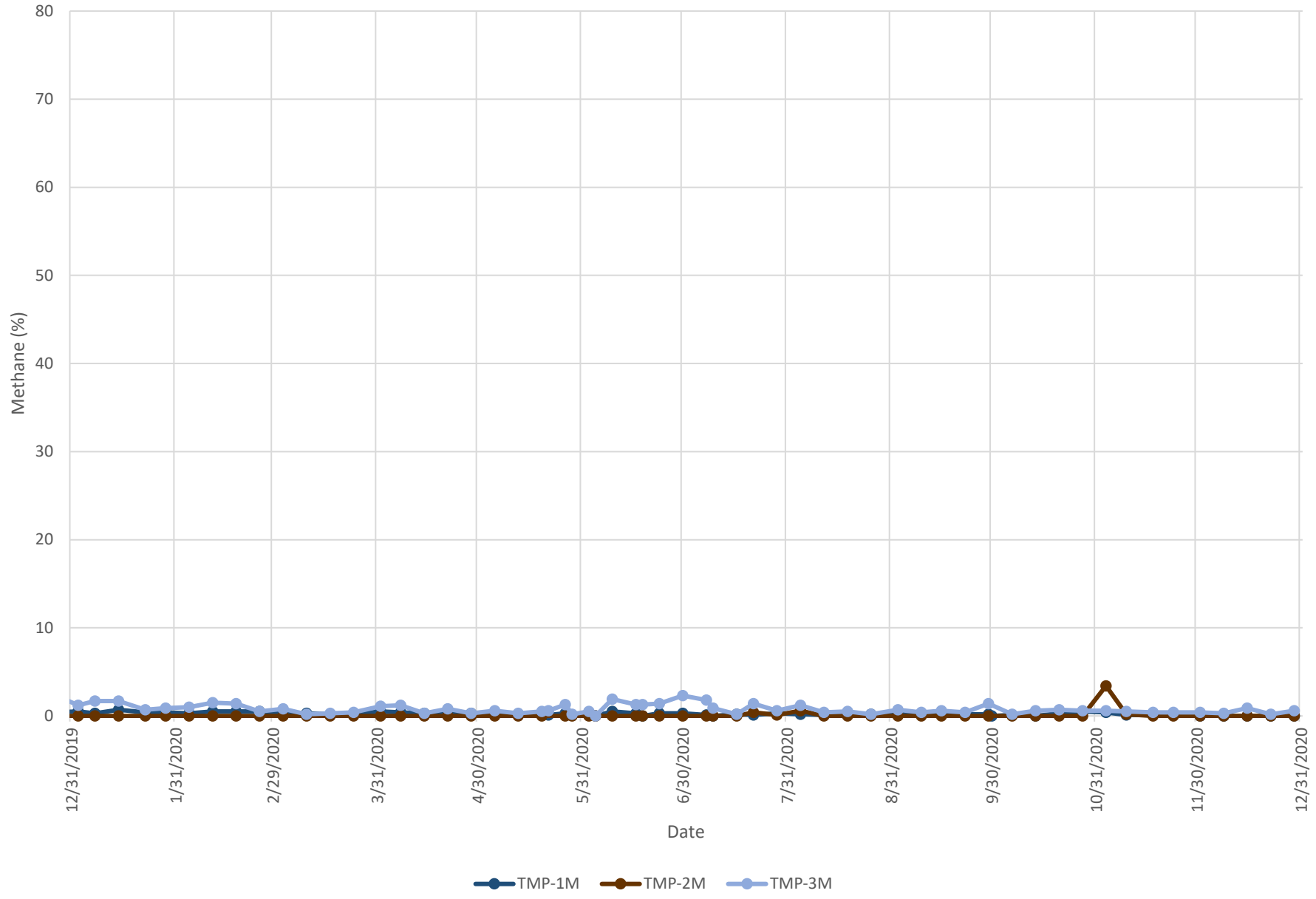

Deep Investigative Probes

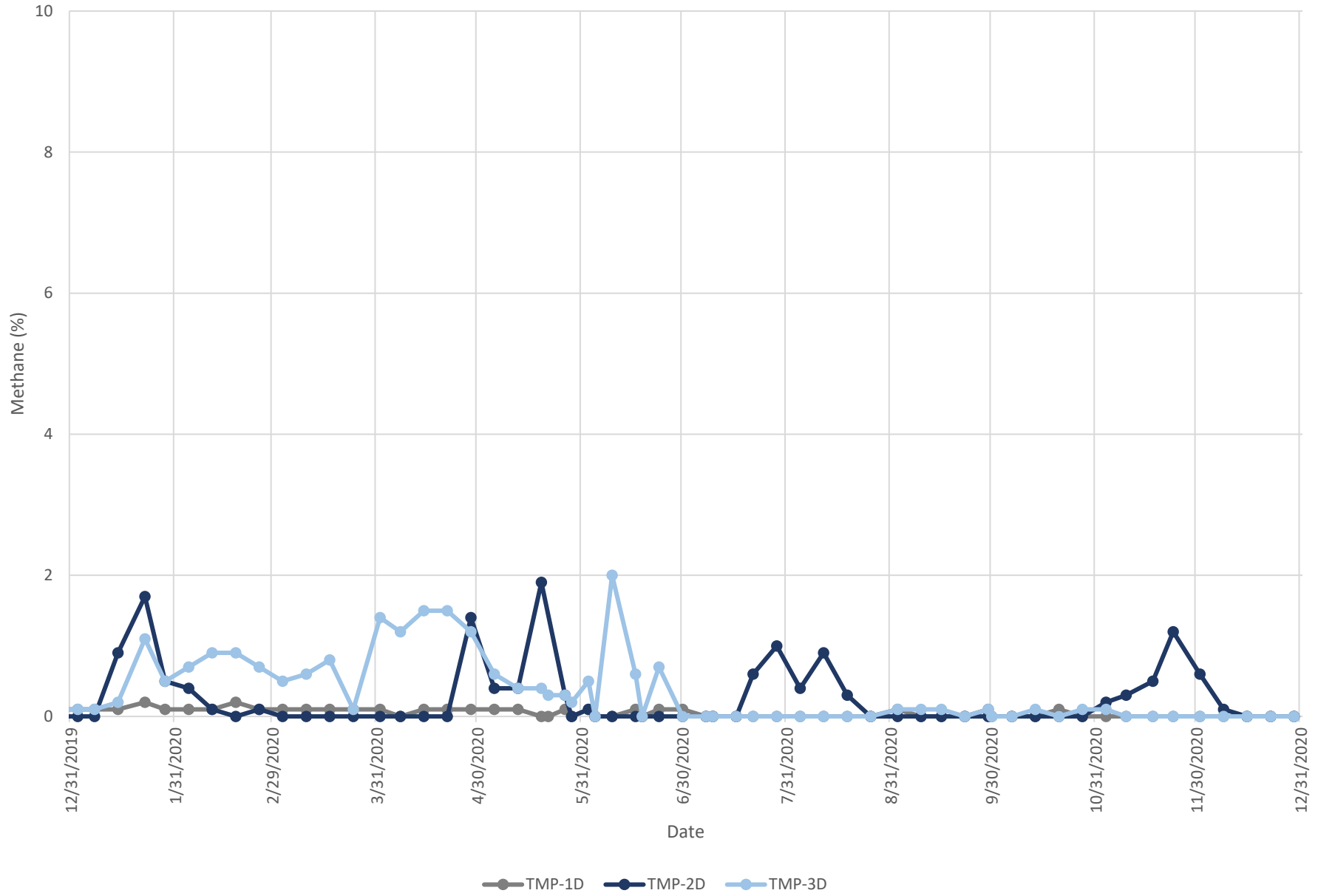

Public Safety Probes

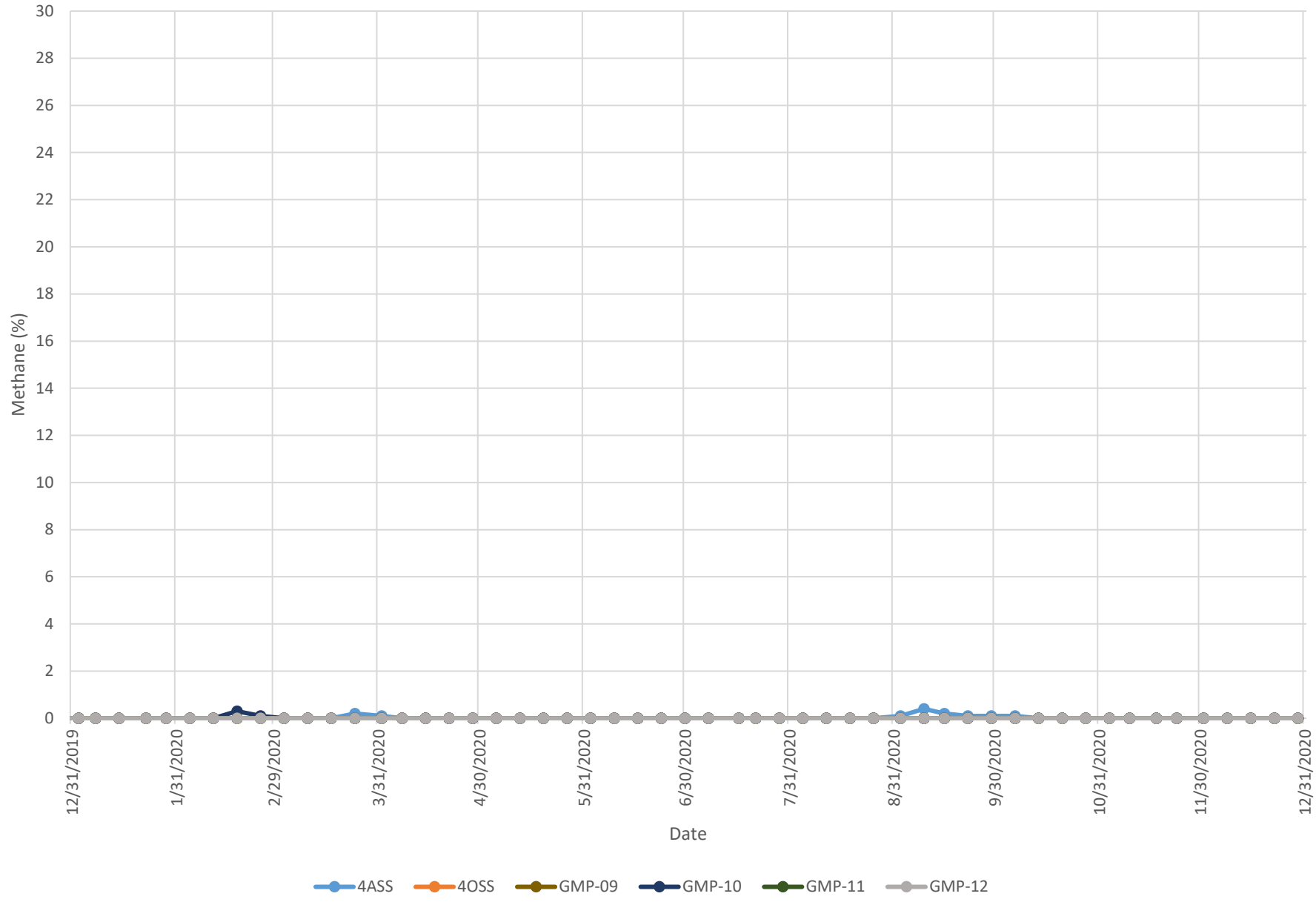

APPENDIX C

INFRASTRUCTURE SITE PLAN, GAS MONITORING PROBE LOCATIONS

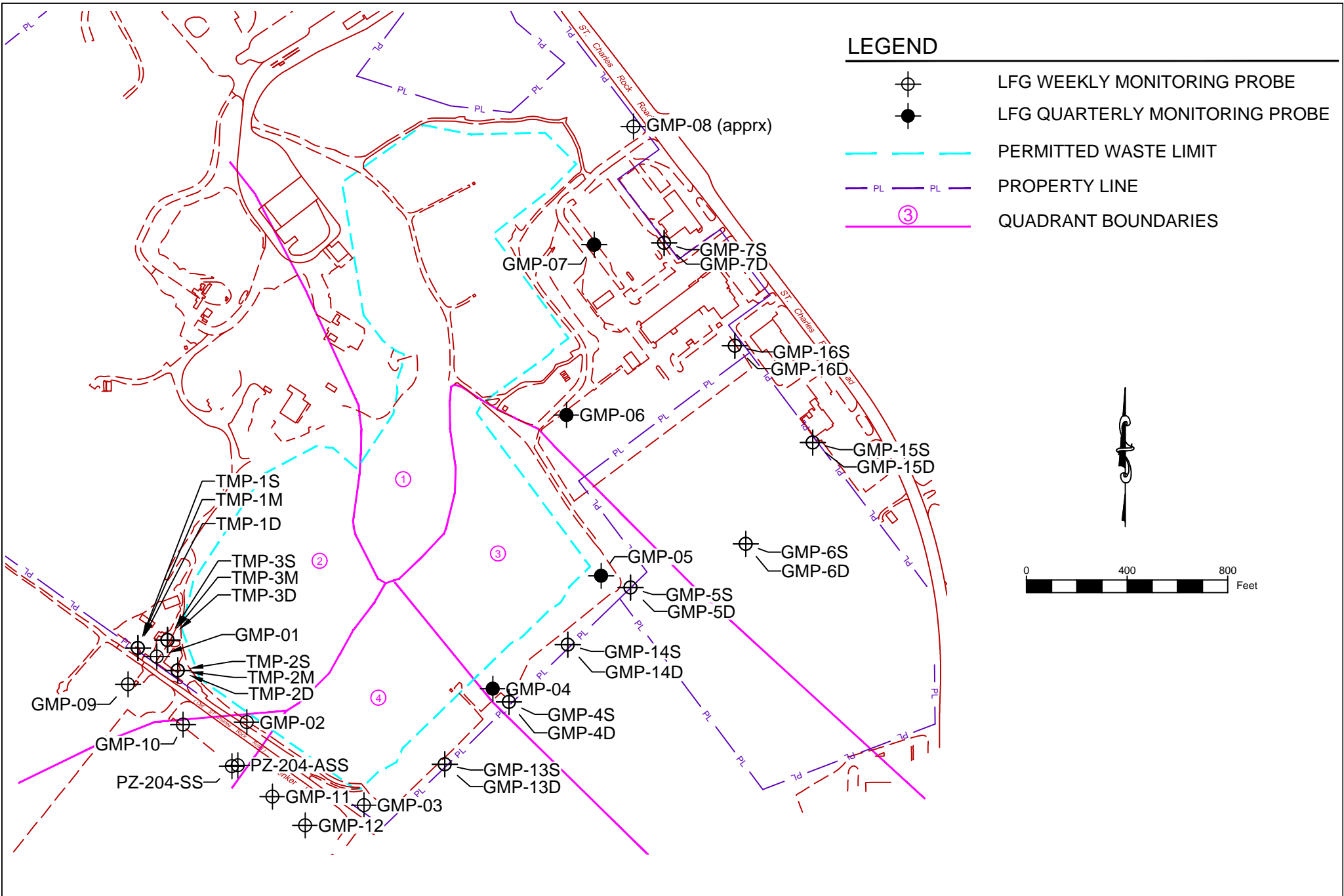

BRIDGETON LANDFILL LLC
 13570 ST. CHARLES ROCK ROAD
 BRIDGETON, MISSOURI 63044

BRIDGETON LANDFILL
 SITE INFRASTRUCTURE



JULY 2020	
DESIGNED BY: PML	
APPROVED BY: ---	
REVISION	DATE

DRAWING NO.:
001

GAS MONITORING PROBES

PROJECT NUMBER: BT-133 | FILE PATH: C:\Users\plins\Dropbox (Feezor Engineering)\Bridgeton\100-149\BT-133 LFG\BT-133 2020to file\gas monitoring system 2nd quarter 2014 - rev.7-8-2020.dwg

APPENDIX D

2020 GCCS IMPROVEMENTS

AS-BUILT RECORD DRAWINGS FOR THE

BRIDGETON LANDFILL

2020 Q3 GCCS INSTALLATION

OCTOBER 2020
PREPARED FOR:

Bridgeton Landfill, LLC

13570 ST. CHARLES ROCK ROAD
BRIDGETON, MISSOURI 63044



3377 HOLLENBERG DRIVE
BRIDGETON, MO 63044
TEL. (217) 483-3118

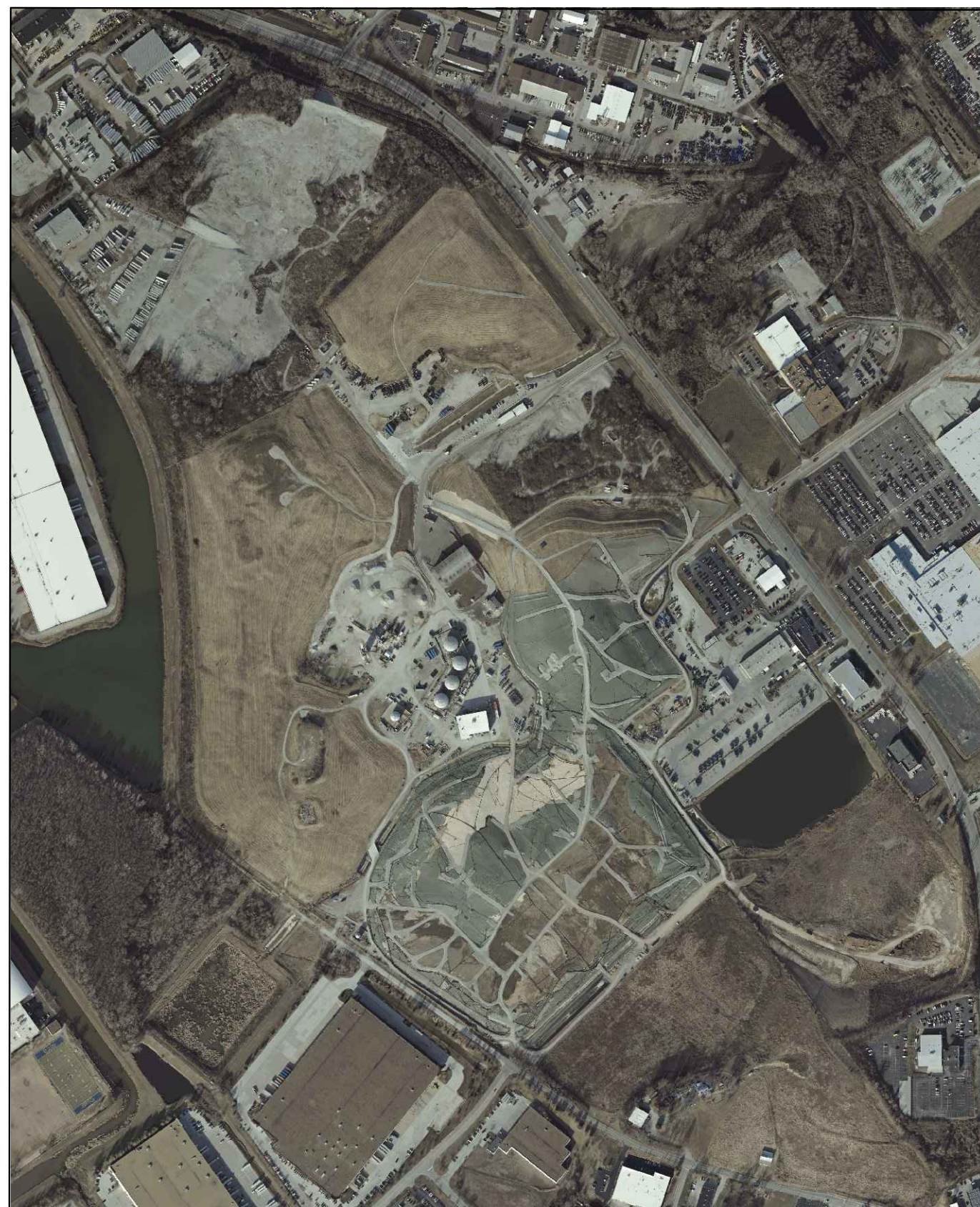

LOCATION MAP

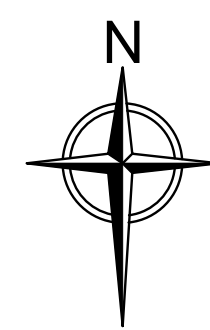

INDEX OF DRAWINGS

	TITLE PAGE
001	2020 GCCS PLAN VIEW
002	DETAILS

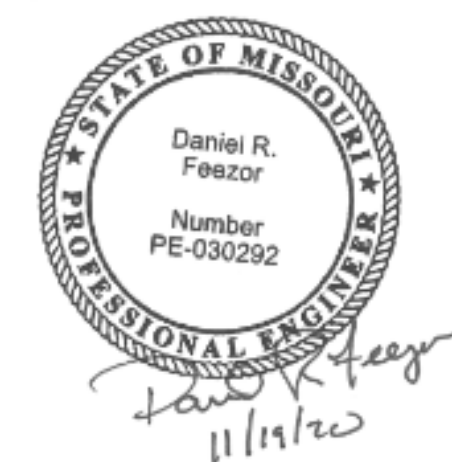



LEGEND

	SOLID WASTE BOUNDARY
	QUARRY WALL
	GAS EXTRACTION WELL
	PERIMETER GAS EXTRACTION WELL
	SURFACE EXTRACTION WELL
	CONDENSATE SUMP
	PERIMETER GAS EXTRACTION WELL
	GAS INTERCEPTOR WELL
	GAS INTERCEPTOR WELL/HEAT EXTRACTION POINT
	GAS EXTRACTION WELL WITH 4" STINGER
	INSTALLED 2020 Q3 GAS EXTRACTION WELL
	INSTALLED HDPE LFG LATERAL (SIZE VARIES)
	INSTALLED 2" HDPE AIRLINE
	INSTALLED 2"x4" HDPE FORCEMAIN

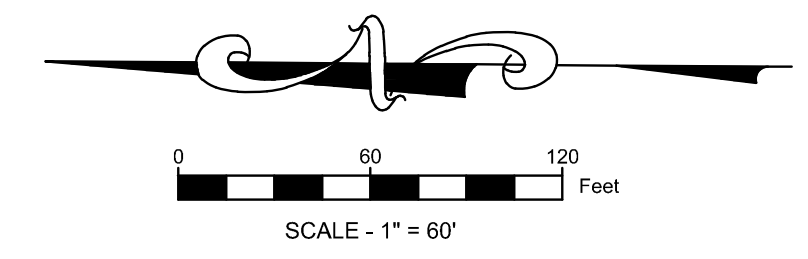

NOTES:
 AERIAL TOPOGRAPHY PROVIDED BY COOPER AERIAL SURVEYS CO. AND IS DATED DECEMBER 10, 2019

	PREPARED BY: DANIEL RICHARD FEZOR PE-030292	PROJECT: BRIDGETON LANDFILL 2020 Q3 GCCS INSTALLATION AS-BUILT RECORD DRAWINGS BRIDGETON, ST. LOUIS COUNTY, MO	PREPARED FOR: BRIDGETON LANDFILL, L.L.C. 13570 ST. CHARLES ROCK ROAD BRIDGETON, MISSOURI 63044	DATE: NOVEMBER 2020	DRAWING #: 001									
	 Engineering for a Better World 3377 Hubenberg Dr., Bridgeton, MO 63044, Ph. 217-483-3119 Missouri State Certificate Of Authority # 1-200912211	DRAWING TITLE: 2020 GCCS PLAN VIEW	DESIGNED BY: AMR APPROVED BY: DRF	REVISIONS: DATE DSN APV.	PROJECT NUMBER: BT-14320 FILE PATH: C:\Users\amr\Desktop\Bridgeton\2020Q3\2020Q3GCCS\2020Q3GCCS_PlanView.dwg	<table border="1"> <tr> <td> </td> <td> </td> <td> </td> </tr> <tr> <td> </td> <td> </td> <td> </td> </tr> <tr> <td> </td> <td> </td> <td> </td> </tr> </table>								

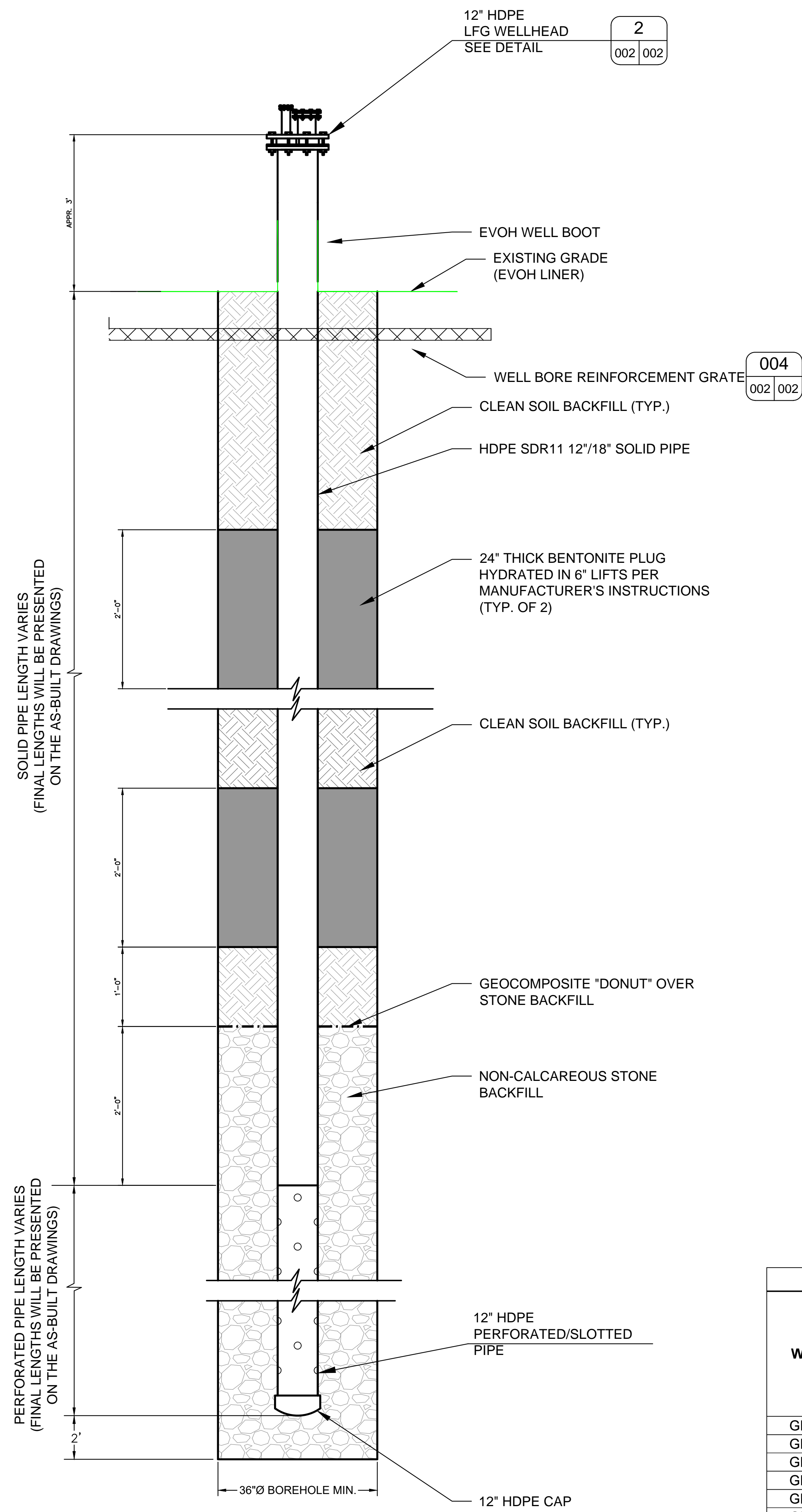

SOUTH QUARRY LFG EXTRACTION WELL DETAIL
NOT TO SCALE

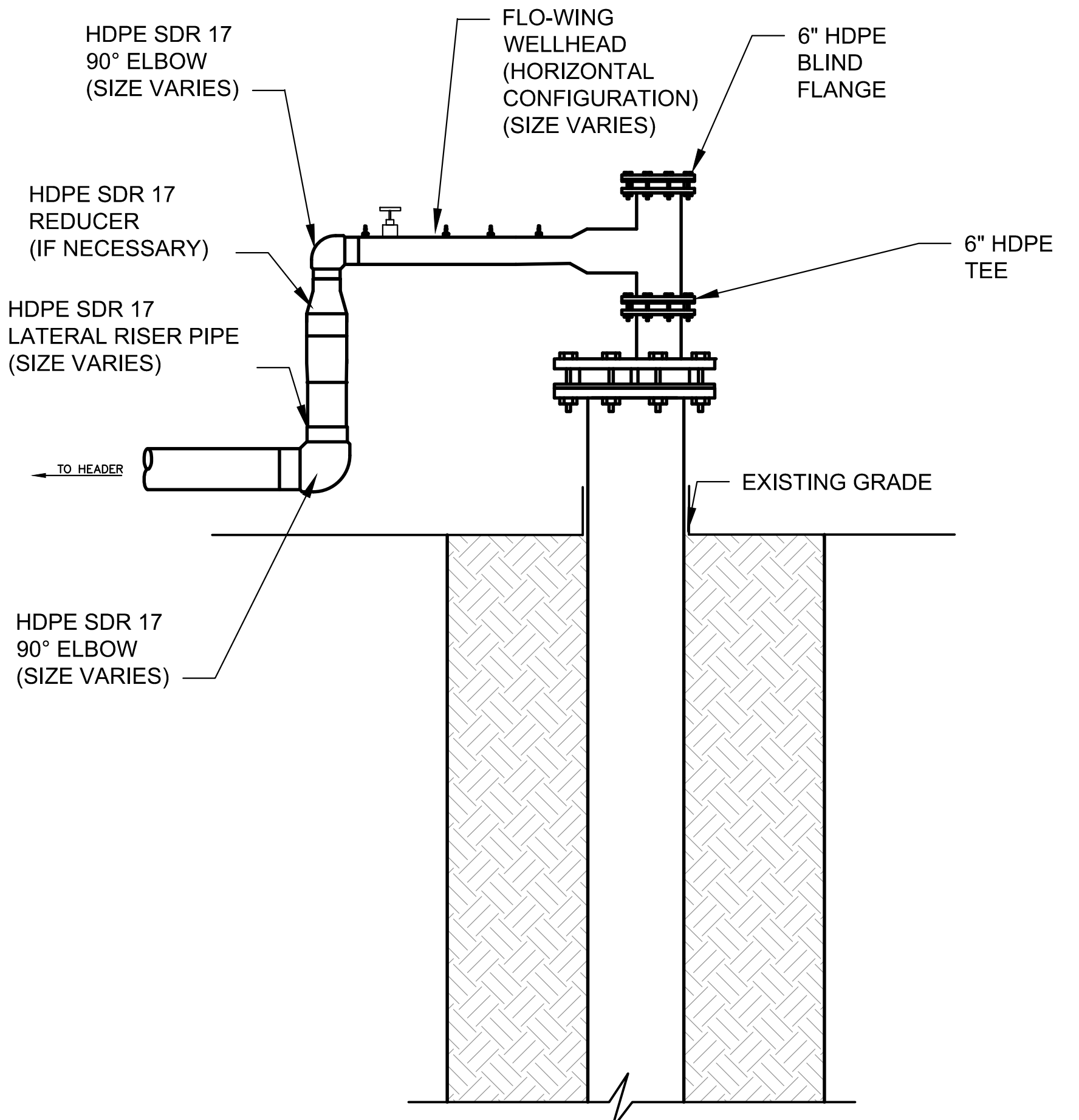

GEW WELLHEAD DETAIL
NOT TO SCALE

NOTES:
1. CONTRACTOR WILL INSTALL BRIDGETON LANDFILL TYPICAL WELLHEAD.

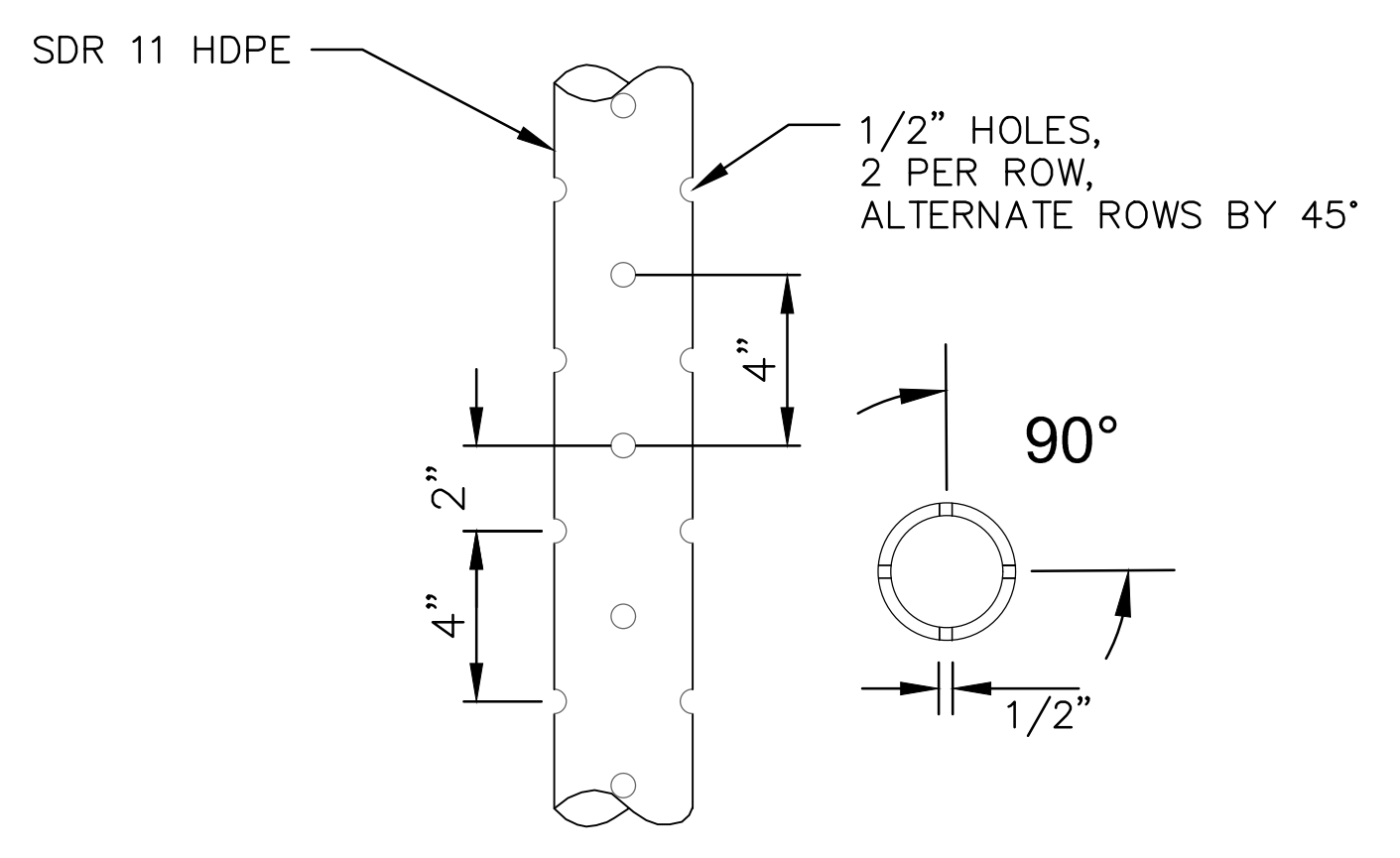

NOTES:
1. PERFORATIONS SPACED 90° APART HORIZONTALLY.
2. PERFORATIONS SPACED 4" APART VERTICALLY.
3. 90° AND 270° ROWS STAGGERED 2" BELOW 0° AND 180° ROWS.

3 PERFORATED PIPE DETAIL
NOT TO SCALE

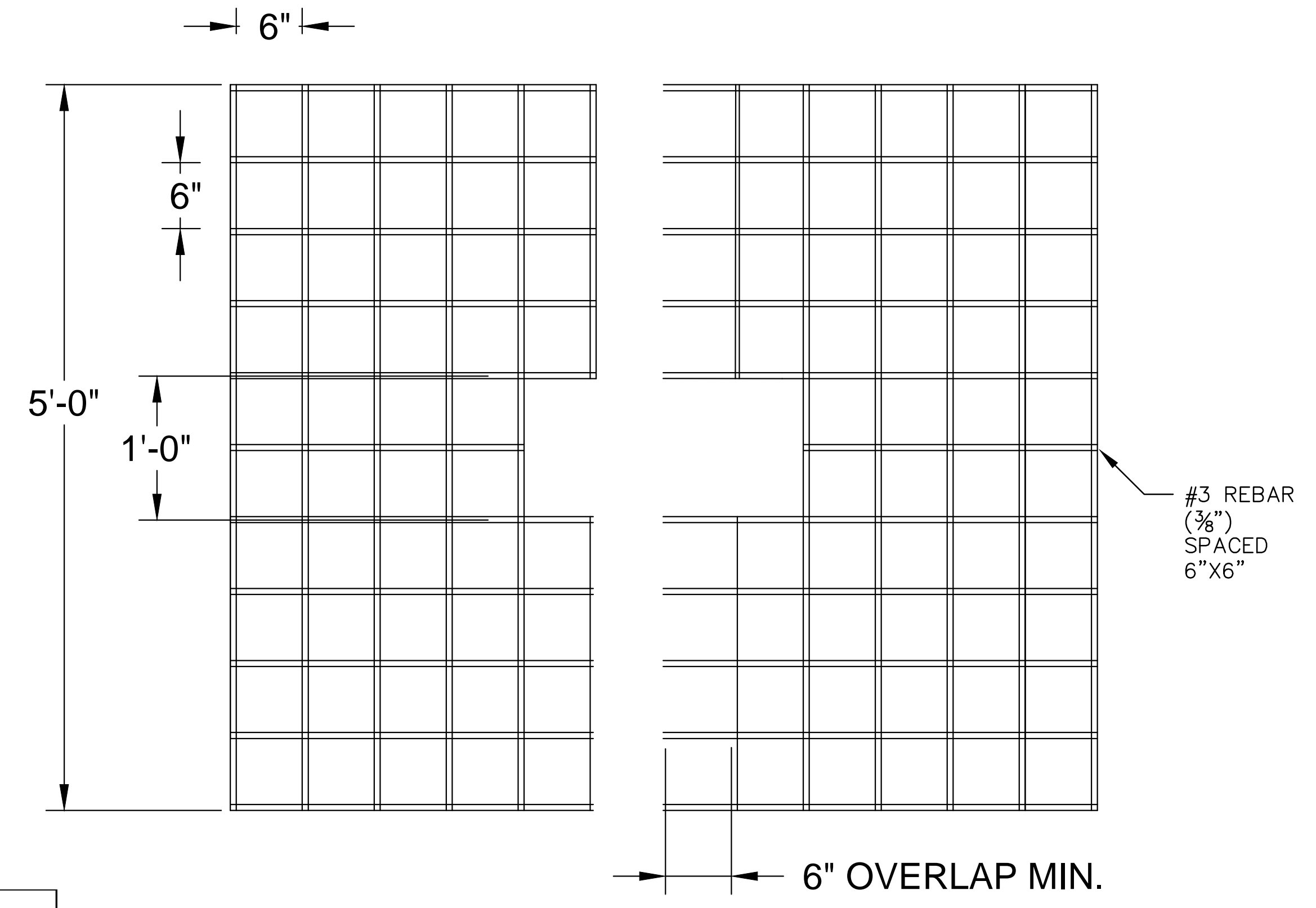

4 WELL BORE REINFORCEMENT GRATE
NOT TO SCALE

NOTES:
1. WELL BORE REINFORCEMENT GRATE INSTALLED APPR. 6" BELOW GRADE.

WELL ID	Northing	Easting	2020 Q3 WELL SCHEDULE			Db Boring Depth (Feet)	Solid Pipe Above Grade (Feet)	Solid Pipe Below Grade (Feet)	Dp Perforated Pipe (Feet)	Thickness of Gravel Pack (Feet)
			Ground Elevation (As-Built Survey) (Feet MSL)	Bottom of Boring (Feet MSL)	Quarry Bottom 1979 Topo (Feet MSL)					
GEW-241	1,067,108.8	516,733.4	490.0	414.0	359.2	76	2	19	55	59
GEW-242	1,067,032.0	516,547.4	492.3	415.3	240.0	77	2	43	32	36
GEW-243	1,066,580.0	515,828.1	488.7	398.7	276.9	90	2	19	69	73
GEW-244	1,066,662.0	515,750.6	487.7	367.7	275.0	120	3	19	99	103
GEW-245	1,066,708.0	515,639.7	482.8	399.8	354.4	83	2	24	57	61
GEW-246	1,067,552.0	515,915.6	473.4	380.4	246.6	93	2	19	72	76
GEW-247	1,067,494.0	516,528.6	483.4	417.4	240.0	66	3	18	46	50
GEW-248	1,067,383.0	516,531.8	488.8	426.8	240.0	62	2	19	41	45
GEW-249	1,067,255.0	516,794.7	494.5	374.5	240.0	120	3	19	99	103
GEW-250	1,067,116.0	515,458.9	468.6	387.6	340.0	81	3	19	60	64
GEW-251	1,067,451.0	516,129.0	474.4	394.4	240.0	80	2	18	60	64
GEW-252	1,067,186.0	516,530.2	493.0	402.0	240.0	91	3	23	66	70
GEW-253	1,066,998.0	515,828.9	495.9	421.9	240.0	74	2	19	53	57

Notes:
"Quarry Bottom" elevation taken from 1979 topography obtained from Aquaterra

NOTES:
AERIAL TOPOGRAPHY PROVIDED BY COOPER AERIAL SURVEYS CO. AND IS DATED DECEMBER 10, 2019

	FEZOR ENGINEERING, INC. 3377 Holtenberg Dr., Bridgeton, MO 63044, Ph: 217-483-3119 Missouri State Certificate Of Authority #: E-200912211	PROJECT: BRIDGETON LANDFILL 2020 Q3 GCOS INSTALLATION AS-BUILT RECORD DRAWINGS BRIDGETON, ST. LOUIS COUNTY, MO DRAWING TITLE:	PREPARED FOR: BRIDGETON LANDFILL, L.L.C. 13570 ST. CHARLES ROCK ROAD BRIDGETON, MISSOURI 63044	NOVEMBER 2020 DESIGNED BY: AMR APPROVED BY: DRF REVISIONS:	DRAWING # 002 DATE: DSN: APV:
--	---	--	--	---	---

PROJECT NUMBER: BT-14320 | FILE PATH: C:\Users\Fezor\Engineering\Bridgeton\08-160BT-143\2017 Gas Well\2020 Q3 AS-Built\Appendix C - Drawings

APPENDIX E

**AS-BUILT BORING LOCATIONS – DRAWING 003 (FROM GEOPROBE AS-BUILT
REPORT**

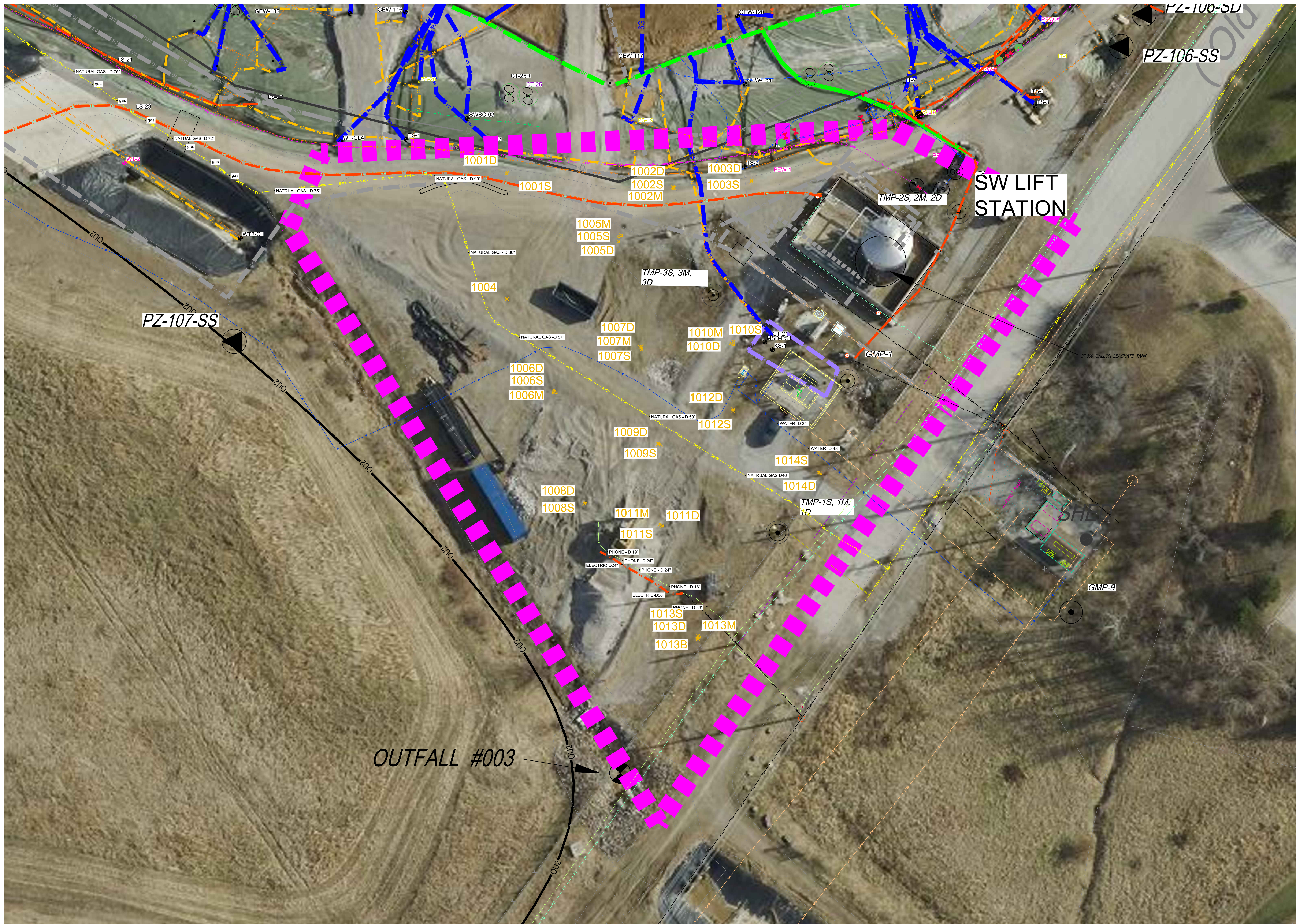

LEGEND

	SOLID WASTE BOUNDARY
	QUARRY WALL
	WEST LAKE AREA 1
	WEST LAKE AREA 2
	GAS MONITORING PROBE
	TEMPORARY GAS MONITORING PROBE
	PIEZOMETER MONITORING WELL
	GAS EXTRACTION WELL
	INTERCEPTOR TRENCH SUMP
	SURFACE EXTRACTION WELL
	PERIMETER GAS EXTRACTION WELL
	LFG ISOLATION VALVE
	LEACHATE ISOLATION VALVE
	FLOW METER
	GRIT CHAMBER
	LIFT STATION
	CONDENSATE SUMP
	CONDENSATE TRAP/HEADER CONNECTION SUMP
	LEACHATE COLLECTION SUMP
	HORIZONTAL COLLECTION SUMP
	PERIMETER SUMP
	LEACHATE COLLECTION SUMP
	SURFACE COLLECTOR
	TEMPERATURE MONITORING PROBE
	SUBSURFACE RCP WELLS
	TRENCH SUMP
	INTERCEPTION TRENCH RISSER
	PERIMETER LEACHATE SUMP
	WELL HEAD RISSER
	WELL BORE BOOT
	TRENCH SUMP
	OVER LINER TIE IN POINT
	GAS INTERCEPTOR WELL
	GAS INTERCEPTOR WELL/HEAT EXTRACTION POINT
	CLEAN OUT
	GAS EXTRACTION WELL WITH 4' STINGER
	EXTRACTION POINT - ABANDONED
	EXTRACTION POINT - TEMPORARILY DECOMMISSIONED
	CONTAINMENT SUMP PUMP STATION FOR TOE STRIP DRAIN
	DOWNSLOPE STRIP DRAIN COLLECTOR 6\"/>
	QUADRANT #
	POWER PANEL
	QUARRY WALL
	LEACHATE COLLECTION PIPING
	DUAL CONTAINED LCS FORCEMAIN (SIZE VARIES)
	DUAL CONTAINED PERIMETER FORCEMAIN (SIZE VARIES)
	LEACHATE COLLECTION PIPING (SIZE VARIES)
	TOE DRAIN
	4\"/>
	BUBBLE SUCKER
	AIR LINE
	AIR LINE (PRESSURIZED BELOW GROUND)
	BURIED LFG COLLECTION PIPING (SIZE VARIES)
	2\"/>
	4\"/>
	6\"/>
	8\"/>
	10\"/>
	12\"/>
	18\"/>
	24\"/>
	2\" PRESSURIZED AIR / 2\" FORCEMAIN IN COMMON TRENCH
	ABOVEGROUND ELECTRIC LINE
	OVERHEAD ELECTRIC LINE
	UNDERGROUND ELECTRIC LINE
	SANITARY SEWER
	MSD DISCHARGE FORCEMAIN
	WATERMAIN
	NATURAL GAS LINE
	FIBER OPTIC LINE
	TELEPHONE
	FENCE LINE
	INTERCEPTOR TRENCH
	HEAT EXTRACTION EFFLUENT PIPING
	HEAT EXTRACTION INFLUENT PIPING
	WORK PLAN AREA
	AS-BUILT GEOPROBE LOCATION

SCALE - 1" = 20'

DISCLAIMER:
 THE EXISTENCE AND APPROXIMATE LOCATION OF UTILITIES KNOWN TO EXIST, AS SHOWN ON THESE DRAWINGS ARE BASED ON THE BEST INFORMATION PROVIDED TO FEI AT THE TIME OF THIS SUBMITTAL. THIS INFORMATION HAS BEEN PROVIDED TO FEI AS-IS AND FEI EXPRESSLY DISCLAIMS ANY REPRESENTATION OR WARRANTY AS TO THE COMPLETENESS OR ACCURACY OF THE INFORMATION FOR ANY USE. IT IS THE RESPONSIBILITY OF ANY PARTIES PERFORMING WORK TO VERIFY THE EXISTENCE, LOCATION AND STATUS OF ANY FACILITY. SUCH VERIFICATION INCLUDES DIRECT CONTACT WITH THE LISTED UTILITIES.

NOTES:
 * AERIAL TOPOGRAPHY PROVIDED BY COOPER AERIAL SURVEYS CO. AND IS DATED DECEMBER 10, 2019

PREPARED BY: 3377 Hallenberg Dr. Bridgeton, MO 63044 Ph: 217-483-3118 Missouri State Certificate of Authority # E-200912213	PROJECT: BRIDGETON LANDFILL SOIL GAS MONITORING WORK PLAN BRIDGETON, ST. LOUIS COUNTY, MO	PREPARED FOR: BRIDGETON LANDFILL, LLC 13570 ST. CHARLES ROCK ROAD BRIDGETON, MISSOURI 63044	MAY 2020 DESIGNED BY: AMR APPROVED BY: DRP 003
DRAWING TITLE: AS-BUILT BORING LOCATIONS			REVISIONS:
PROJECT NUMBER: BT-209 FILE PATH: C:\Users\amr\OneDrive\Documents\Bridgeton\003\04\Soil Gas\AS-Built\AS-Built Boring Locations\AS-Built Boring Locations.dwg			DATE: DSN: APV: